



Chapter Goals

- Identify different types of wireless technologies.
- Identify different wireless solutions.
- Introduce quadrature amplitude modulation.
- Explain wireless systems.
- Discuss the benefits of using wireless technologies for communications.

Wireless Technologies

Types of Wireless Technology

Eighteen major types of wireless technologies exist, containing a large number of subset technologies that range from ATM-protocol based (which sells at approximately \$200,000 per data link, to wireless local-area network (WLAN, which sells at less than \$500,000 per data link). Frequencies of the different technologies travel between several hundred feet (wireless LAN) and 25 miles (MMDS).

The process by which radio waves are propagated through the air, the amount of data carried, immunity to interference from internal and external sources, and a host of other characteristics varies from technology to technology.

Wireless technologies are differentiated by the following:

- **Protocol**—ATM or IP
- **Connection type**—Point-to-Point (P2P) or multipoint (P2MP) connections
- **Spectrum**—Licensed or unlicensed

Table 20-1 lists the different wireless technologies.

Table 20-1 Different Types of Wireless Technologies

Broadband ¹	Narrowband
WAN	WAN and WLAN
Licensed ²	Unlicensed
Digital	Analog
Line-of-site ³	Non-line-of-site

Table 20-1 Different Types of Wireless Technologies (continued)

Broadband ¹	Narrowband
Simplex ⁴	Half-/full-Duplex
Point-to-point	Multipoint

1. Broadband—Data rates that exceed 1.5 Mbps
2. Licensed—Granted by or purchased from the FCC
3. Line-of-site—Direct line of site between two antennae
4. Simplex—One transmitter

Base Station

The *base station* (also referred to as the hub or the cell site) is the central location that collects all traffic to and from subscribers within a cell. The indoor base station equipment consists of channel groups. The channel groups each connect to the existing network, typically with a DS-3 with ATM signaling. The function of the channel group is to effectively act as a high-speed radio modem for the DS-3 traffic. The outdoor base station equipment (Tx/Rx node) modules are located on a tower or a rooftop mount and consist of a frequency translation hardware and transmitters/receivers. The Tx/Rx node delivers and collects all the traffic to and from subscribers within a cell or a sector. Additionally, the Tx/Rx node equipment translates the channel group output into the appropriate frequency for over-the-air transmission. Multiple channel groups are used in each sector to meet the traffic demands, thus providing a highly scalable architecture.

Introduction to QAM

Many modern fixed microwave communication systems are based on quadrature amplitude modulation (QAM). These systems have various levels of complexity.

Simpler systems such as phase shift keying (PSK) are very robust and easy to implement because they have low data rates. In PSK modulation, the shape of the wave is modified in neither amplitude nor frequency, but rather in phase. The phase can be thought of as a shift in time. In binary phase shift keying (BPSK), the phases for the sine wave start at either 0 or $1/4$. In BPSK modulation, only 1 bit is transmitted per cycle (called a symbol). In more complex modulation schemes, more than 1 bit is transmitted per symbol. The modulation scheme QPSK (quadrature phase shift keying) is similar to the BPSK. However, instead of only two separate phase states, QPSK uses four (0 , $1/2$, $3/4$, and 1), carrying 2 bits per symbol. Like BPSK, QPSK is used because of its robustness. However, because it modulates only 2 bits per symbol, it still is not very efficient for high-speed communications. Hence, higher bit rates require the use of significant bandwidth.

Even though QPSK uses no state changes in amplitude, it is sometimes referred to as 4-QAM. When four levels of amplitude are combined with the four levels of phase, we get 16-QAM. In 16 QAM, 2 bits are encoded on phase changes, and 2 bits are encoded on amplitude changes, yielding a total of 4 bits per symbol.

In Figure 20-1, each unique phase is spaced equally in both the I and Q coordinates. The angle of rotation indicates the phase, and the distance from the center point indicates the amplitude. This approach to modulation can be expanded out to 64-QAM and 256-QAM or higher. Although 64-QAM is very popular in both cable and wireless broadband products, 256-QAM is also being tested. The higher the density in QAM, the higher a signal-to-noise (s/n) ratio must be maintained to meet the required bit-error rates (BERs).

Figure 20-1 Error Rates for PSK and QAM Systems

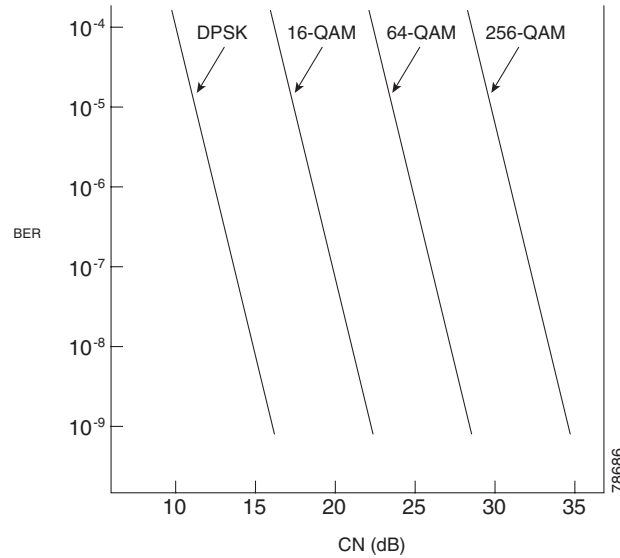

How the data is encoded also plays an important part in the equation. The data is usually scrambled, and a significant amount of forward error correction (FEC) data is also transmitted. Therefore, the system can recover those bits that are lost because of noise, multipath, and interference. A significant improvement in BER is achieved using FEC for a given SNR at the receiver. (See Figure 20-2.)

Figure 20-2 BER Against Signal-to-Noise for Coded and Uncoded Data Streams

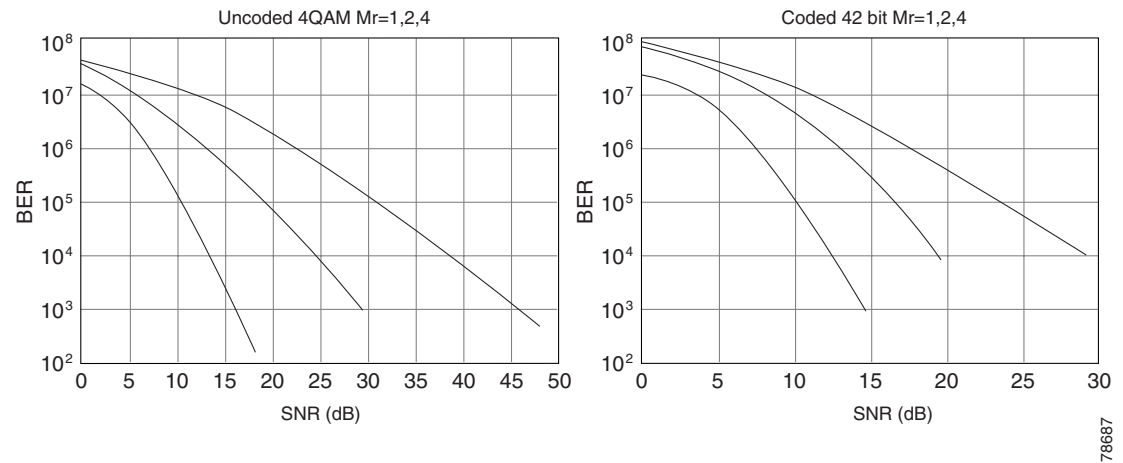

Advanced Signaling Techniques Used to Mitigate Multipath

Several techniques have been used to make digital modulation schemes more robust: QAM with decision feedback equalization (DFE), direct sequence spread spectrum (DSSS), frequency-division multiplexing (FDM), and orthogonal frequency-division multiplexing (OFDM).

QAM with DFE

In wireless QAM systems, DFE is used to mitigate the effects of the intersymbol interference (ISI) caused by multipath. When delay spread is present, the echoes of previous symbols corrupt the sampling instant for the current symbol. The DFE filter oversamples the incoming signal and filters out the echoed carriers. The complexity of DFE schemes causes them not to scale with increases in bandwidth. The complexity of the DFE filter (number of taps) is proportional to the size of the delay spread. The number of required taps is proportional to the delay spread (in seconds) multiplied by the symbol rate.

For a QAM-based wireless system transmitting in the MMDS band (6-MHz-wide channel) to survive a 4- μ sec delay spread, the number of taps required would equal 24. To equalize a system with 24 taps, a DFE system would need 72 feedforward and 24 feedback taps. In addition to the number of taps needed, the complexity of the math needed for each tap increases with the number of taps. Therefore, the increase in complexity becomes an exponential function of the bandwidth of the carrier signal. Figure 20-3 compares the complexity rate of QAM/DFE and OFDM. Orthogonal frequency-division multiplexing (OFDM) is discussed later in this paper.

Figure 20-3 Computational Complexity of QAM Versus OFDM

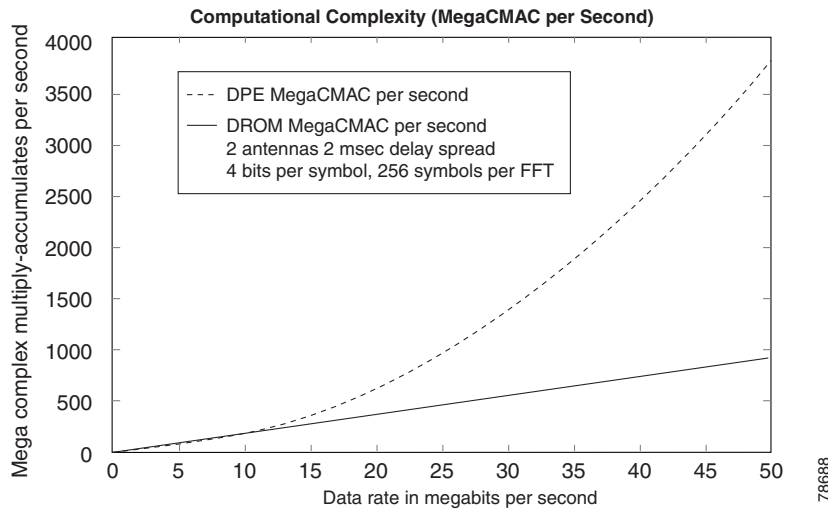

Spread Spectrum

Spread spectrum is a method commonly used to modulate the information into manageable bits that are sent over the air wirelessly. Spread spectrum was invented by Hedy Lamar, a film actress who still retains the patent to this day and was the relatively recent recipient of a governmental award for this accomplishment.

Essentially, spread spectrum refers to the concept of splitting information over a series of radio channels or frequencies. Generally, the number of frequencies is in the range of about 70, and the information is sent over all or most of the frequencies before being demodulated, or combined at the receiving end of the radio system.

Two kinds of spread spectrum are available:

- Direct sequence spread spectrum (DSSS)
- Frequency hopping spread spectrum (FHSS)

DSSS typically has better performance, while FHSS is typically more resilient to interference.

A commonly used analogy to understand spread spectrum is that of a series of trains departing a station at the same time. The payload is distributed relatively equally among the trains, which all depart at the same time. Upon arrival at the destination, the payload is taken off each train and is collated.

Duplications of payload are common to spread spectrum so that when data arrives excessively corrupted, or fails to arrive, the redundancies inherent to this architecture provide a more robust data link.

Direct sequence spread spectrum (DSSS) is a signaling method that avoids the complexity and the need for equalization. Generally, a narrowband QPSK signal is used. This narrowband signal is then multiplied (or spread) across a much wider bandwidth. The amount of spectrum needed is expressed as: $10(\text{SNR}/10) \times \text{narrowband symbol rate}$.

Therefore, if a SNR of 20 dB is required to achieve the appropriate BER, the total spread bandwidth needed to transmit a digital signal of 6 Mbps equals 600 MHz.

This is not very bandwidth-efficient. In addition, the sampling rate for the receiver needs to be about 100 times the data rate. Therefore, for this hypothetical system, the sampling rate would also need to be 600 megasamples per second.

With DSSS, all trains leave in an order beginning with Train 1 and ending with Train N, depending on how many channels the spread spectrum system allocates. In the DSSS architecture, the trains always leave in the same order, although the numbers of railroad tracks can be in the hundreds or even thousands.

Code division multiple access (CDMA) is used to allow several simultaneous transmissions to occur. Each data stream is multiplied with a pseudorandom noise code (PN code). All users in a CDMA system use the same frequency band. Each signal is spread out and layered on top of each other and is overlaid using code spreading in the same time slot. The transmitted signal is recovered by using the PN code. Data transmitted by other users looks like white noise and drops out during the reception phase. Any narrowband noise is dispersed during the de-spreading of the data signal. The advantage of CDMA is that the amount of bandwidth required is now shared over several users. However, in systems in which there are multiple transmitters and receivers, proper power management is needed to ensure that one user does not overpower other users in the same spectrum. These power management issues are mainly confined to CDMA architectures.

FHSS

With the *FHSS* architecture, the trains leave in a different order—that is, not sequentially from Train 1 to Train N. In the best of FHSS systems, trains that run into interference are not sent out again until the interference abates. In FHSS systems, certain frequencies (channels) are avoided until the interference abates.

Interference tends to cover more than one channel at a time. Therefore, DSSS systems tend to lose more data from interference as the data sent out is done so over sequential channels. FHSS systems hop between channels in nonsequential order. The best of FHSS systems adjust channel selection so that highly interfered channels are avoided as measured by excessively low bit error rates. Either approach is appropriate and depends on customer requirements, with the selection criteria primarily being that of a severe multipath or interfering RF environment.

FDM

In a *frequency-division multiplexing (FDM)* system, the available bandwidth is divided into multiple data carriers. The data to be transmitted is then divided among these subcarriers. Because each carrier is treated independently of the others, a frequency guard band must be placed around it. This guard band

lowers the bandwidth efficiency. In some FDM systems, up to 50 percent of the available bandwidth is wasted. In most FDM systems, individual users are segmented to a particular subcarrier; therefore, their burst rate cannot exceed the capacity of that subcarrier. If some subcarriers are idle, their bandwidth cannot be shared with other subcarriers.

OFDM

In *OFDM* (see Figure 20-4), multiple carriers (or tones) are used to divide the data across the available spectrum, similar to FDM. However, in an OFDM system, each tone is considered to be orthogonal (independent or unrelated) to the adjacent tones and, therefore, does not require a guard band. Because OFDM requires guard bands only around a set of tones, it is more efficient spectrally than FDM. Because OFDM is made up of many narrowband tones, narrowband interference will degrade only a small portion of the signal and has no or little effect on the remainder of the frequency components.

Figure 20-4 Example of OFDM Tones

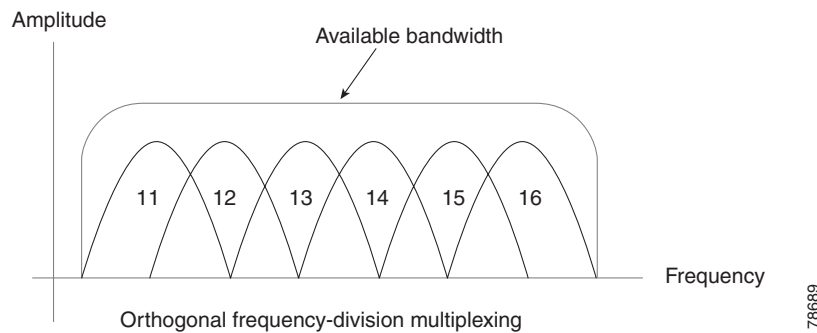

OFDM systems use bursts of data to minimize ISI caused by delay spread. Data is transmitted in bursts, and each burst consists of a cyclic prefix followed by data symbols. An example OFDM signal occupying 6 MHz is made up of 512 individual carriers (or tones), each carrying a single QAM symbol per burst. The cyclic prefix is used to absorb transients from previous bursts caused by multipath signals. An additional 64 symbols are transmitted for the cyclic prefix. For each symbol period, a total of 576 symbols are transmitted by only 512 unique QAM symbols per burst. In general, by the time the cyclic prefix is over, the resulting waveform created by the combining multipath signals is not a function of any samples from the previous burst. Hence, there is no ISI. The cyclic prefix must be greater than the delay spread of the multipath signals. In a 6-MHz system, the individual sample rate is 0.16 μ secs. Therefore, the total time for the cyclic prefix is 10.24 μ secs, greater than the anticipated 4 μ secs delay spread.

VOFDM

In addition to the standard OFDM principles, the use of spatial diversity can increase the system's tolerance to noise, interference, and multipath. This is referred to as *vectored OFDM*, or *VOFDM* (see Figure 20-5). Spatial diversity is a widely accepted technique for improving performance in multipath environments. Because multipath is a function of the collection of bounced signals, that collection is dependent on the location of the receiver antenna. If two or more antennae are placed in the system, each would have a different set of multipath signals. The effects of each channel would vary from one antenna to the next, so carriers that may be unusable on one antenna may become usable on another. Antenna spacing is at least ten times the wavelength.

Significant gains in the S/N are obtained by using multiple antennae. Typically, a second antenna adds about 3 dB in LOS and up to 10 dB in non-LOS environments.

Figure 20-5 Spectrum Technology

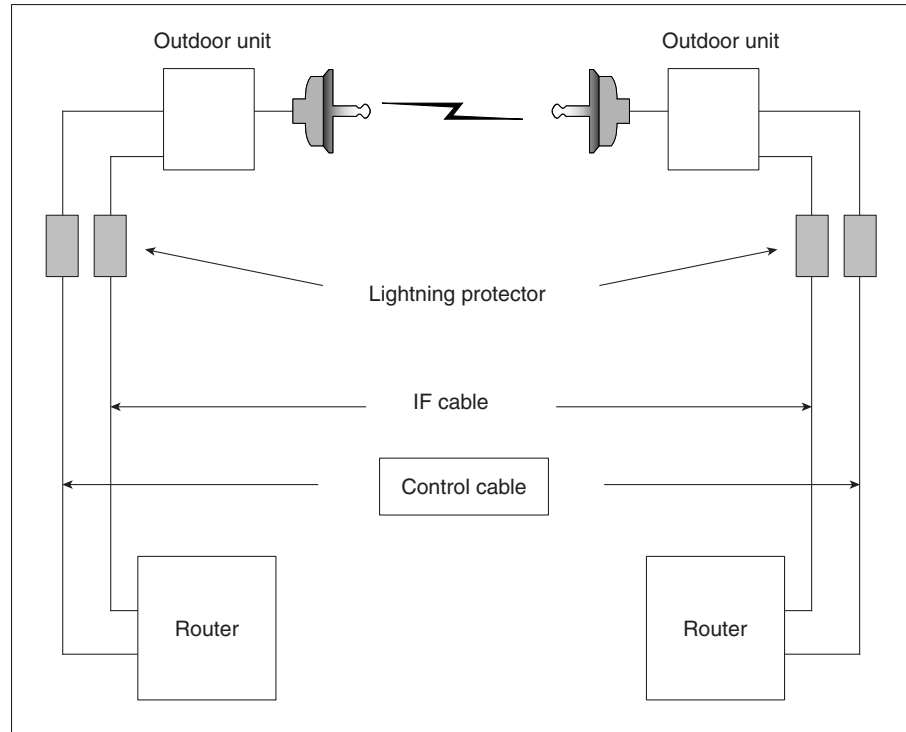

Benefits of Using Wireless Solutions

The following list summarizes the main benefits of using wireless technologies:

- **Completes the access technology portfolio**—Customers commonly use more than one access technology to service various parts of their network and during the migration phase of their networks, when upgrading occurs on a scheduled basis. Wireless enables a fully comprehensive access technology portfolio to work with existing dial, cable, and DSL technologies.
- **Goes where cable and fiber cannot**—The inherent nature of wireless is that it doesn't require wires or lines to accommodate the data/voice/video pipeline. As such, the system will carry information across geographical areas that are prohibitive in terms of distance, cost, access, or time. It also sidesteps the numerous issues of ILEC colocation.

Although paying fees for access to elevated areas such as masts, towers, and building tops is not unusual, these fees, the associated logistics, and contractual agreements are often minimal compared to the costs of trenching cable.

- **Involves reduced time to revenue**—Companies can generate revenue in less time through the deployment of wireless solutions than with comparable access technologies because a wireless system can be assembled and brought online in as little as two to three hours.

This technology enables service providers to sell access without having to wait for cable-trenching operations to complete or for incumbent providers to provide access or backhaul.

- **Provides broadband access extension**—Wireless commonly both competes with and complements existing broadband access. Wireless technologies play a key role in extending the reach of cable, fiber, and DSL markets, and it does so quickly and reliably. It also commonly provides a competitive alternative to broadband wireline or provides access in geographies that don't qualify for loop access.

Earth Curvature Calculation for Line-of-Sight Systems

Line-of-sight systems that carry data over distances in excess of 10 miles require additional care and calculations. Because curvature of the Earth causes bulges at the approximate rate of 10 feet for every 18 miles, a calculation is required to maintain line-of-sight status.

The *Fresnel* (pronounced fren-NEL) *zone* refers to that which must clear the Earth's bulge and other obstructions. This is the elliptically shaped free space area directly between the antennae. The center area in this zone is of the greatest importance and is called the first Fresnel zone. Although the entire Fresnel zone covers an area of appreciable diameter between the antennae, the first Fresnel zone is considered as a radius about the axis between the antennae. A calculation is required to determine the radius (in feet) that must remain free from obstruction for optimal data transfer rates. The formula for this calculation is: $D^2/8$.

Table 20-22 helps to calculate the distance/bulge ratio.

Table 20-2 Wireless Distance Calculations

Distance (Miles)	Earth Bulge
8	8.0
10	12.5
12	18.0
14	24.5
16	32.0

While observing these calculations, it's important to remember that this accounts only for Earth bulge. Vegetation such as trees and other objects such as buildings must have their elevations added into this formula. A reasonable rule of thumb is 75 feet of elevation at both ends of the data link for a distance of 25 miles, but this should be considered an approximation only.

$$R_{ft} = 72.1 \times \text{the square root of } d1 \times d2 / F \times D$$

Where:

Rft = radius of the first Fresnel zone in feet

F = carrier frequency

d1 = distance from the transmitter to the first path obstacle

d2 = distance from the path obstacle to the receiver

D = d1 + d2 (in miles)

The industry standard is to keep 60 percent of the first Fresnel zone clear from obstacles. Therefore, the result of this calculation can be reduced by up to 60 percent without appreciable interference. This calculation should be considered as a reference only and does not account for the phenomenon of refraction from highly reflective surfaces.

Non-Line-of-Sight Wireless: Overcoming Multipath in Non-Line-of-Sight High-Speed

Microwave Communication Links

Since the beginning of development of microwave wireless transmission equipment, manufacturers and operators have tried to mitigate the effects of reflected signals associated with signal propagation. These reflections are called multipath. In real-world situations, microwave systems involve careful design to overcome the effects of multipath. Most existing multipath mitigation approaches fall well short of the full reliable information rate potential of many wireless communications systems. This section discusses how to create a digital microwave transmission system that not only can tolerate multipath signals, but that also can actually take advantage of them.

Digital microwave systems fall into two categories: wavelengths less than 10 GHz and wavelengths greater than 10 GHz (referred to as millimeterwave). Several bands exist below 10 GHz for high-speed transmissions. These may be licensed bands, such as MMDS (2.5 GHz), or unlicensed bands, such as U-NII (5.7 GHz). Bands that are below 10 GHz have long propagation distances (up to 30 miles). They are only mildly affected by climatic changes such as rain. These frequencies are generally not absorbed by objects in the environment. They tend to bound and thus result in a high amount of multipath.

Bands over 10 GHz, such as 24 GHz, LMDS (28 GHz), and 38 GHz, are very limited to distance (less than 5 miles). They are also quite susceptible to signal fades attributed to rain. Multipath tends not to be an issue because the transmission distances are less and because most of the multipath energy is absorbed by the physical environment. However, when these frequencies are used in highly dense urban areas, the signals tend to bounce off objects such as metal buildings or metalized windows. The use of repeaters can add to the multipath propagation by delaying the received signal.

What Is Multipath?

Multipath is the composition of a primary signal plus duplicate or echoed images caused by reflections of signals off objects between the transmitter and the receiver. In Figure 20-6, the receiver hears the primary signal sent directly from the transmission facility, but it also sees secondary signals that are bounced off nearby objects.

These bounced signals will arrive at the receiver later than the incident signal. Because of this misalignment, the out-of-phase signals will cause intersymbol interference or distortion of the received signal. Although most of the multipath is caused by bounces off tall objects, multipath can also occur from bounces off low objects such as lakes and pavement.

Figure 20-6 Multipath Reception

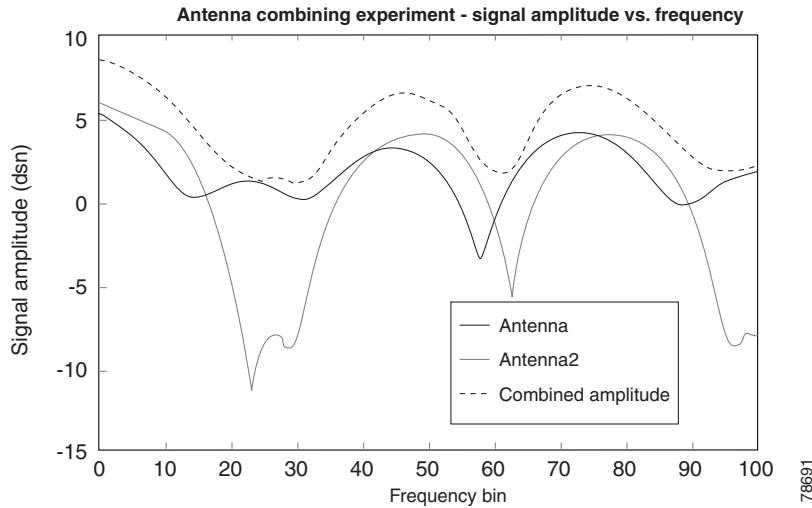

The actual received signal is a combination of a primary signal and several echoed signals. Because the distance traveled by the original signal is shorter than the bounced signal, the time differential causes two signals to be received. These signals are overlapped and combined into a single one. In real life, the time between the first received signal and the last echoed signal is called the delay spread, which can be as high as 4 μ sec.

In the example shown in Figure 20-7, the echoed signal is delayed in time and reduced in power. Both are caused by the additional distance that the bounced signal traveled over the primary signal. The greater the distance, the longer the delay and the lower the power of the echoed signal. You might think that the longer the delay, the better off the reception would be. However, if the delay is too long, the reception of an echoed symbol S1 and the primary symbol S2 can also interact. Because there may be no direct path for the incident signal in non-line-of-sight (LOS) environments, the primary signal may be small in comparison to other secondary signals.

Figure 20-7 Typical Multipath Example

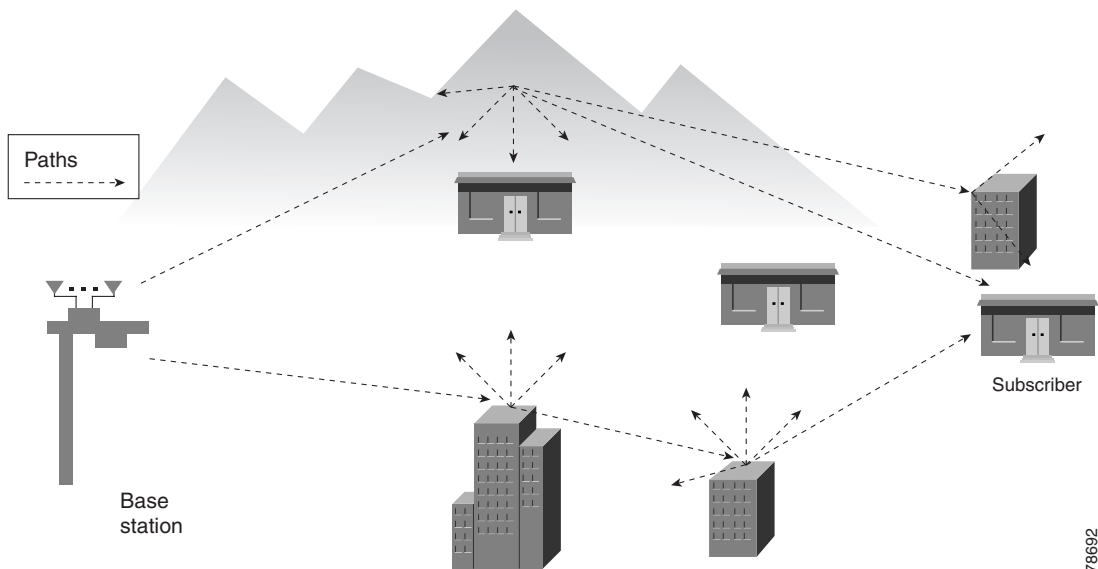

In analog systems such as television, this multipath situation can actually be seen by the human eye. Sometimes there is a ghost image on your television, and no matter how much you adjust the set, the image does not go away. In these analog systems, this is an annoyance. In digital systems, it usually corrupts the data stream and causes loss of data or lower performance. Correction algorithms must be put in place to compensate for the multipath, resulting in a lower available data rate.

In digital systems, the input signal is sampled at the symbol rate. The echoed signal actually interferes with the reception of the second symbol, thus causing intersymbol interference (ISI). This ISI is the main result of multipath, and digital systems must be designed to deal with it.

Multipath in Non-LOS Environments

In LOS environments, multipath is usually minor and can be overcome easily. The amplitudes of the echoed signals are much smaller than the primary one and can be effectively filtered out using standard equalization techniques. However, in non-LOS environments, the echoed signals may have higher power levels because the primary signal may be partially or totally obstructed, and generally because more multipath is present. This makes the equalization design more difficult.

In all the previous discussions, the multipath has been a semifixed event. However, other factors such as moving objects enter into play. The particular multipath condition changes from one sample period to the next. This is called time variation. Digital systems must be capable of withstanding fast changes in the multipath conditions, referred to as *fast fading*. To deal with this condition, digital systems need fast AGC circuits. Adaptive equalizers, discussed next, need fast training times.

Elements of a Total Network Solution

The issue of what comprises a solution is the subject of considerable discussion and conjecture. Commonly, the term solution includes the following primary elements:

- Premises networks
- Access networks
- Core networks
- Network management
- Billing/OSS

A fully comprehensive wireless solution must also include the issues of deployment, maintenance, legacy, migration, and value propositions. The scope of what comprises a fully comprehensive solution can readily exceed these items.

Premises Networks

Premises networks are the voice, data, or video distribution networks that exist or will exist within the subscriber premises. Typical points of demarcation between the access and premises networks for purposes of this discussion include channel banks, PBXs, routers, or multiservice access devices.

Customer premises equipment receives signals from the hub, translates them into customer-usable data, and transmits returning data back to the hub. The transmitter, the receiver, and the antenna are generally housed in a compact rooftop unit (RTU) that is smaller than a satellite TV minidish. It is mounted on the subscriber's roof in a location where it will have a clear line of sight to the nearest LMDS hub site. Installation includes semiprecision pointing to ensure maximum performance of the RF link.

The indoor unit, the network interface unit (NIU), does the modulation, demodulation, in-building wire-line interface functions, and provides an intermediate frequency to the RTU. Many interfaces required by end customer equipment require the NIU to have a breadth of physical and logical interfaces. The NIUs are designed to address a range of targeted subscribers whose connectivity requirements may range from T1/E1, POTS, Ethernet, or any other standard network interface. These interfaces are provided by the NIU with interworking function (IWF) cards. Different types of IWF cards are required in the NIU to convert the inputs into ATM cells and provide the appropriate signaling. Common IWFs include 10BaseT, T1/E1 circuit emulation, and others. The NIU also has an IF that is translated by the CPE RTU.

Access Networks

The *access networks* are the transport and distribution networks that bridge the premises network and the core network demarcation points. For purposes of this discussion, the primary means of providing the transport from an access network point-of-presence (POP) to the premises is radio and the distribution between access network POPs is either fiber or radio.

Core Networks

The *core networks* are the public or private backbone networks that, in a general sense, will be utilized by the access network operators to connect their multitude of regionally dispersed POPs and to interconnect to public service provider network elements. For purposes of this discussion, the point of demarcation between the access network and the core network is a core switch that serves as an upstream destination point for a multitude of access network branches or elements.

Network Management

The glue that ties all the network elements together and supports the key information processing tasks that make a business run effectively is performed by the *Network Management System (NMS)* inclusive of Operational Support System (OSS) functionality. In its full implementation, the NMS is an exceptionally complex set of moderately to highly integrated software platforms. For the purposes of this document, the element managers necessary within each system-level piece of the access network are assumed, but the overarching NMS is beyond the intended scope of this document.

Ideally, the NMS should provide end-to-end functionality throughout both the wireless and wireline elements of the network, including the backbone and the customer premises. A network management system performs service, network, and element management across multivendor and multitechnology networks, including these:

- Topology management
- Connectivity management
- Event management

The functions of the network management system can be further outlined as follows:

- Integrated topology map that displays an entire set of nodes and links in the network, shown with mapped alarms
- Store of network-wide physical (nodes/links) and logical topology (circuits/PVCs) for inventory
- Customer care interface to provide network and end-user status

- Performance statistics on PCR, SCR, MBS, CDVT, and network/link status
- SLA reporting with customer partitioning, and alerting of customer violations
- Alarm correlation and root-cause analysis
- Network simulation to test whether a problem was completely corrected
- Trouble ticketing/workforce management
- Performance reports based on statistics collected, with customer and network views
- Usage-based billing for ATM connections
- Read-only CNM for viewing network and connection

Deployment

As stated previously, tier 1 customers will utilize Cisco's ecosystem of deployment partners. Deployment for systems covering BTA, MTA, or nationwide footprints requires the following areas of expertise and resources:

- Construction (towers, masts)
- Licensing (FCC and local compliance for RF, construction, and access)
- Site survey (RF environment evaluation)
- Integration (selection and acquisition of various RF components)
- Prime (customer engagement through contract)
- Finance (securing or provisioning of project financing)
- Installation (assembly of components)
- Provisioning (spare components)

Billing and Management of Wireless Systems

The issue of billing and network management is a considerable one. In the most general terms, you should consider the wireless links as a network section managed by the standard Cisco IOS and SNMP tools. Accordingly, key customer items such as billing, dynamic host control, testing, and configuration are managed remotely with standard router tools, as indicated in Figure 20-8.

Figure 20-8 Management Interfaces

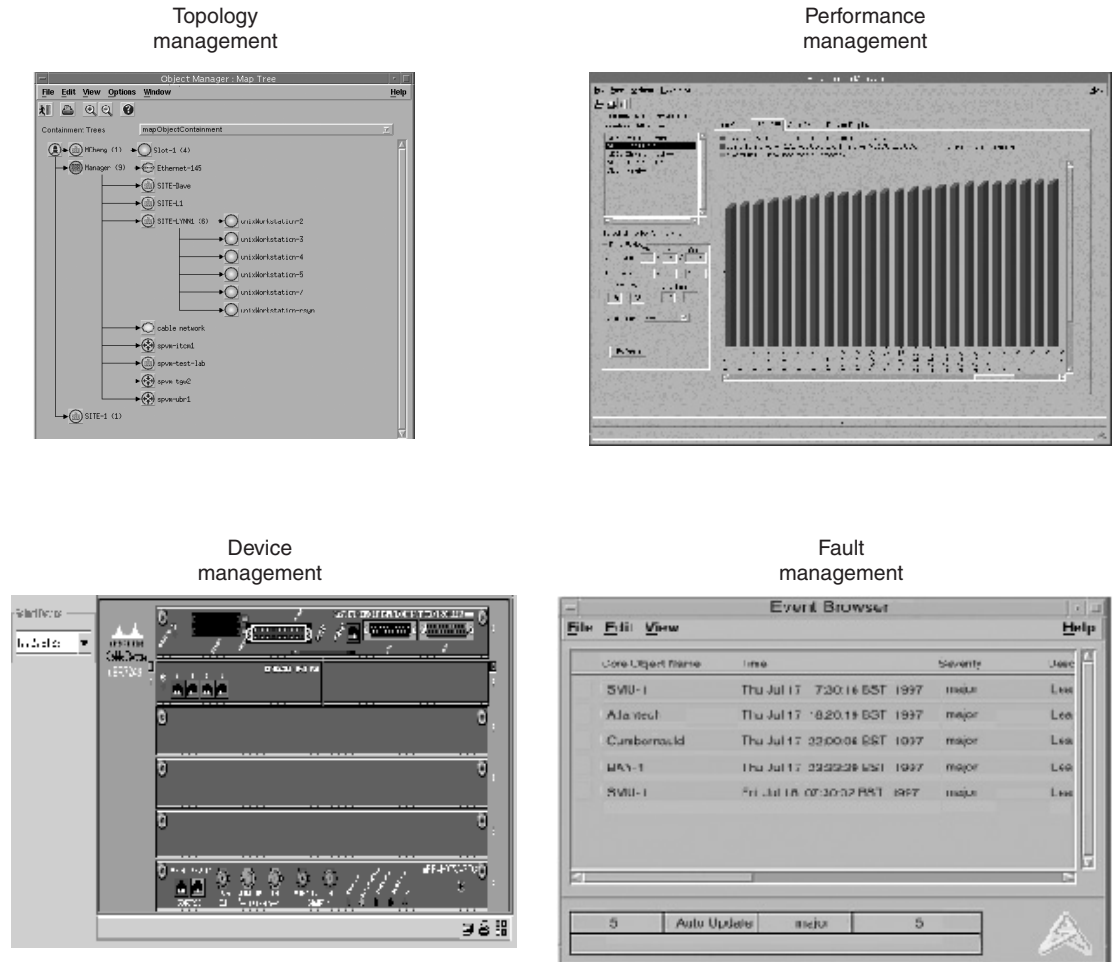

Example Implementation

Cisco's MMDS/U-NII system is designed with the following objectives:

- For a service provider to offer differentiated services via wireless access, the wireless access system should offer higher capacity than alternative access technologies.
- The capacity of the system is increased by three items:
 - A highly efficient physical layer that is robust to interference, resulting in high bandwidth efficiency per sector
 - A statistically efficient industry standard Medium Access Control (MAC) protocol that delivers quality of service (QoS)
 - A multicellular system
- Large bandwidth enables differentiated services such as Voice over IP (VoIP) now, and interactive video in the future, both with QoS.

- A multitiered CPE approach, satisfying the needs of small and medium businesses (SMB), small office/home office (SOHO) applications, and residential customers.
- Ease of base installation and back-haul.
- Ease of provisioning and network management.

IP Wireless System Advantages

Table 20-3 summarizes the advantages of the proposed system.

Table 20-3 Features and Benefits of Wireless Communication

Feature	Benefit
Shared-bandwidth system	Point-to-multipoint wireless architecture Shared bandwidth among many small and medium businesses Burst data rate up to 22 Mbps
Dedicated high-bandwidth System	Point-to-point wireless architecture High data rate (22 to 44 Mbps) Shared head end with point-to-multipoint equipment
Small-cell and single-cell deployment	Variety of available cellular deployment plans Capability to scale with successful service penetration from tens of customers to thousands of customers Single cells of up to 45-km radius Small cells of up to 10-km radius for maximum revenue
Third-generation microwave technology	Higher-percentage coverage of customers in business district Capability of non-line-of-sight technology to service customers that older technology cannot service Capability to configure marginal RF links to improve performance Tolerant of narrow-band interference Receivers capable of adapting to changing environment for every packet Licensed frequency band Options that include unlicensed 5.7- to 5.8-GHz band
Open interfaces	Part of Cisco's dedication to open architectures Partners capable of supplying outdoor unit (ODU), antenna, cable, and all other components outside the router Availability of in-country manufacturers as partners Capability of MAC protocol to enhance DOCSIS, a proven industry multipoint standard

Table 20-3 Features and Benefits of Wireless Communication (continued)

Feature	Benefit
Integrated into Cisco routers	<p>IOS system software and Cisco management software features that treat the radio link as simply another WAN interface</p> <p>Two systems created in one unit: a radio and a multiservice router</p> <p>Wireless integrated into management, provisioning, and billing systems</p> <p>Minimized cost of spare hardware</p>
Native IP	<p>Voice over IP</p> <p>Video over IP</p> <p>Virtual private networks</p> <p>Quality of service</p> <p>Queuing features</p> <p>Traffic policies</p>
Cost-effective solution	<p>Competitively priced</p> <p>Large pool of personnel already trained on Cisco routers and protocols</p> <p>Reduced training time</p> <p>Addition of broadband wireless access to Cisco's total end-to-end network solution and support</p>
Link encryption	<p>Privacy ensured through use of 40/56-bit DES encryption on every user's wireless link</p>

IP Wireless Services for Small and Medium Businesses

The small to medium business (SMB) customer requires services that range from typical Internet data access to business voice services. Most small businesses today have separate voice and data access lines. Almost all SMB customers use native IP in their networks. Voice access lines are typically analog POTS lines or key telephone system (KTS) trunks. As businesses grow, they may require a digital T1 trunk for their private branch exchange (PBX). Data access is typically anything from dial to ISDN, fractional T1 Frame Relay, and potentially up to a dedicated leased line T1 service.

- SMB access technologies include these:
 - Plain Old Telephone Service (POTS)
 - KTS trunks
 - Digital T1 PBX trunks
 - Internet data access (Fast Ethernet)
- SMB service technologies include these:
 - Internet access (IP service)
 - Intranet access (VPN)
 - Voice services (VoIP)
 - Videoconferencing
 - Service-level agreements for guaranteed data rates

- Residential access offerings include these:
 - POTS
 - Internet data access
- Residential service offerings include these:
 - Internet access (IP service)
 - Intranet access
 - Voice services (VoIP)
 - Videoconferencing

IP Point-to-MultiPoint Architecture

The *point-to-multipoint (P2MP)* system consists of a hub, or head end (HE), or a base station (BS),¹ which serves several sectors in the cell. Each sector consists of one radio communicating with many customers.

The head end is an outdoor unit, or transverter, connected to a wireless modem card inside a Cisco UBR7246 or 7223 router.

At the customers' premises is another transverter, which is connected to a wireless network module in a router.

Cisco P2MP objectives are these:

- Integrated end-to-end solution (one box, one management and provisioning platform)
- Complete multiservice offering (Voice over IP, data, Video over IP)
- Scalability and flexibility (scalable head end and CPE offerings)
- Enabled for non-line-of-sight (substantially better coverage)
- Native IP packet transport
- Part of an overall standards-based strategy to provide many Cisco hosts and many frequency bands on a global basis

The shared-bandwidth, or multipoint, product delivers 1 to 22 Mbps aggregate full-duplex, shared-bandwidth, P2MP fixed-site data in the MMDS band for both residential and small business applications, as shown in Figure 20-9.

The P2MP wireless router will be an integrated solution. At the base station (or head end, or hub), it will consist of a base universal router (UBR 7246 or UBR7223), a wireless modem card, an outdoor unit (ODU) for the appropriate frequency band, cables, and antenna subsystems, as shown in Figure 20-10.

At the small business customer premises, the system consists of a network module in a 3600-family router, with an outdoor unit (ODU) and antenna. This CPE equipment is simpler and, therefore, less expensive than the head end (HE) equipment. The 3600 family has a wide variety of interfaces to match all types of customer equipment.

At the SOHO or telecommuter customer premises, the system consists of a network module in a 2600- or 900-family router, with an outdoor unit (ODU) and an antenna. This CPE equipment is simpler and, therefore, less expensive than the head end (HE) equipment. The 2600 and 900 families have a wide variety of interfaces to match all types of customer equipment. A consumer unit by one or more of Cisco's ecosystem partners is expected by the first quarter of 2001.

1. In this document, terms Base Station (BS), Head End (HE), and Hub are used interchangeably.

These wireless broadband routers (WBBR) are then used to blanket an urban area by dividing the business district into small cells.

The product will also be capable of working as a single cell—that is, one hub serving an entire business district in a cell of radius less than 45-miles, because the low frequencies in the MMDS band are not impacted by rain. However, a single cell does not have the revenue potential of small cells. See the section “Title” for the revenue generation potential of these two alternatives.

Figure 20-9 Basic Components of the P2MP Base Station (Head End, Hub)

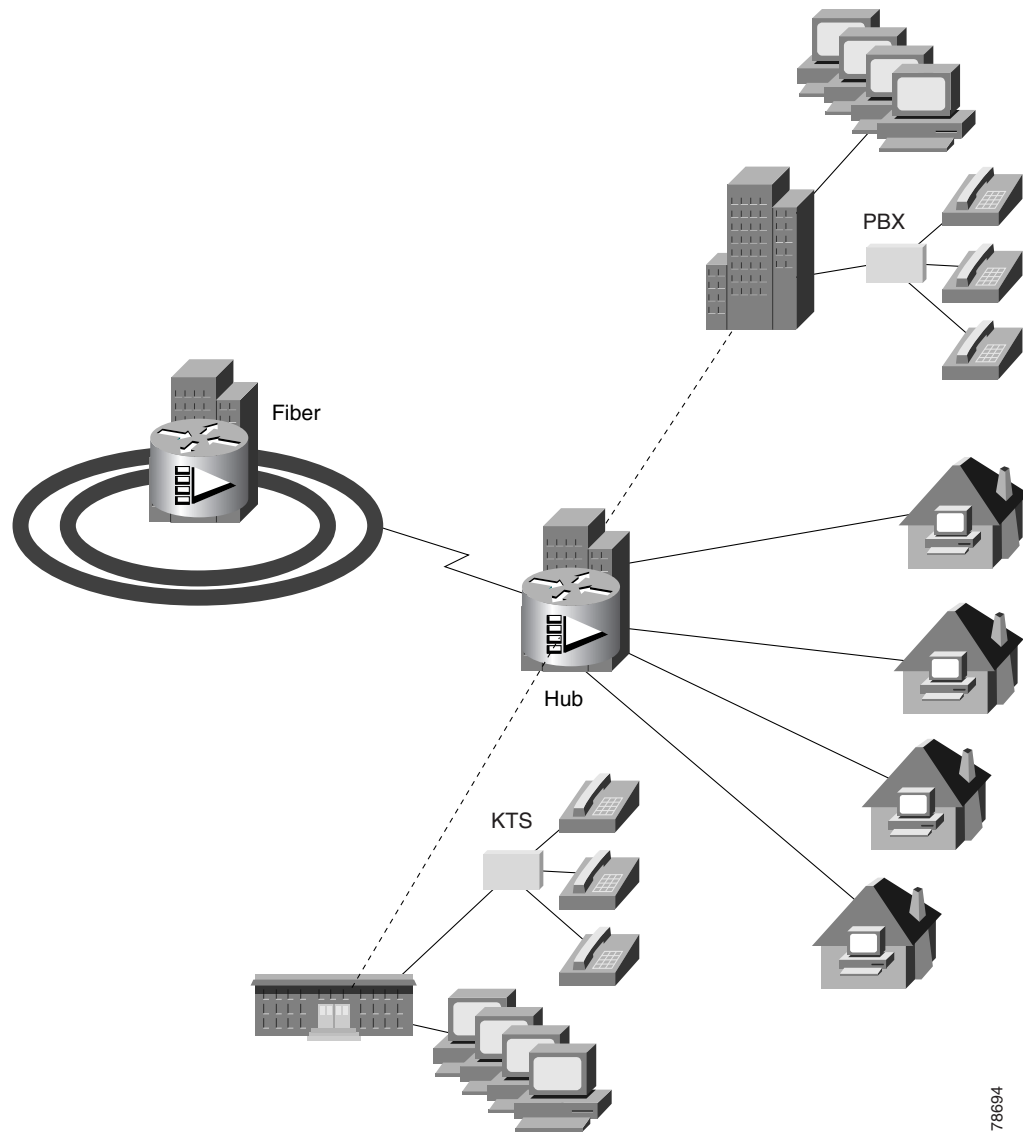
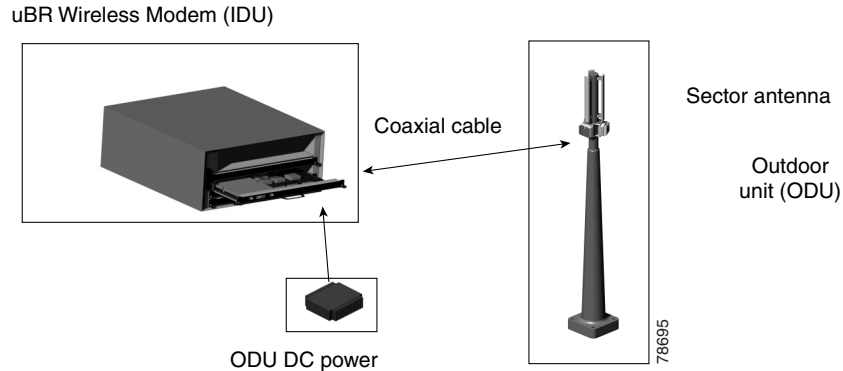

Figure 20-10 The Cisco MMDS Broadband Wireless Access System



Technology has always been a Cisco Systems differentiator, and the proposed system fits that market position. The proposed P2MP system uses patented third-generation microwave technology to overcome the classical microwave constraint that the transmitter and receiver must have a clear line of sight. The proposed technology takes advantage of waves that bounce off buildings, water, and other objects to create multiple paths from the transmitter to the receiver. The receivers are capable of making all these multipath signals combine into one strong signal, rather than having them appear to be interference.

The capability to operate with high levels of multipath permits obstructed links to be deployed. This, in turn, enables multicellular RF deployments and virtually limitless frequency reuse. Also, the antennae in the system can be mounted on short towers or rooftops.

Although this is primarily a savings in the cost of installing a system, it has the added benefit of making the installation less visible to the user's neighbors, which is very important in some regions.

The typical point-to-multipoint system for an SMB is shown in Figure 20-11.

The point-to-point system is similar, except that the customer premises equipment is another UBR7223 or 7246 router. The point-to-point system is shown in Figure 20-12.

Some SMB customers will require a data rate that is higher than the service provider can supply within the traffic capacity of the multipoint system. The service provider may satisfy those customers by installing Cisco's point-to-point (P2P) links from the same hub as the P2MP system. Thus, the hub can be a mixture of P2MP and P2P systems.

In both cases, integrating the wireless card directly into the router brings with it all the Cisco IOS features and network management.

Figure 20-11 Hardware Components of the Point-to-Point System (Only One of Four Possible Sectors Shown on HE Equipment)

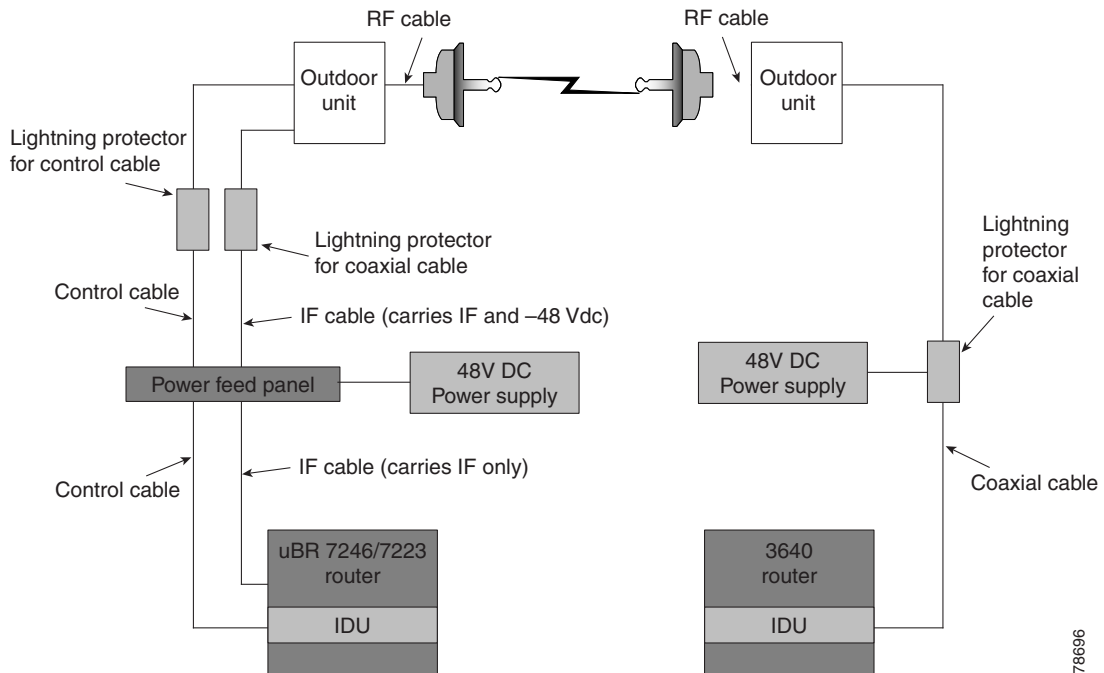

78696

IP Wireless Open Standards

This open architecture permits many different vendors to participate, creating new products, features, and services. Figure 20-13 shows why many vendors will be interested in this approach. By using a common IF, many different frequency bands can be utilized for many different services.

Other router and switch vendors will also be capable of entering the market because the IF-to-WAN conversion is something that they can work into their product line. It also shows how Cisco will migrate the IF into WAN interfaces in a range of existing and future router products.

Equally important, by making the wireless interface just one more WAN interface on a router, Cisco has integrated all the network management for the wireless system into the normal router and switch network management, such as CiscoView and CiscoWorks2000.

Figure 20-12 Hardware Components of the Point-to-Point System

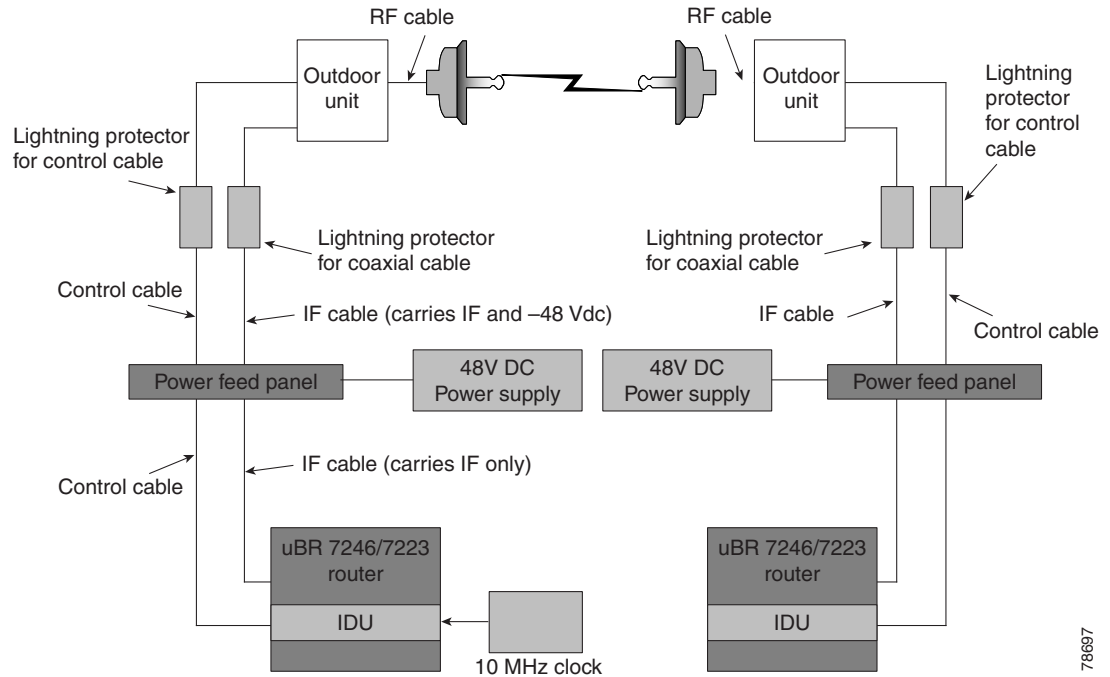

78697

Figure 20-13 Open Standard Wireless Architecture

Changing the Game in Wireless

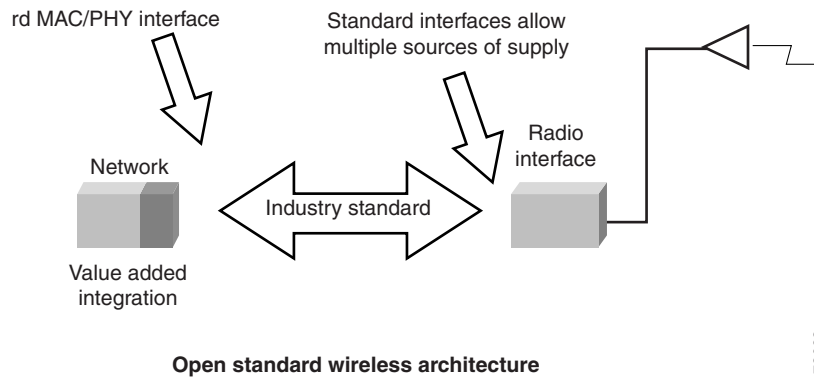

78698

IP Vector Orthogonal Frequency-Division Multiplexing

The system uses the next-generation microwave technology invented by Cisco Systems, called *vector orthogonal frequency-division multiplexing (VOFDM)*, to resolve the issue of multipath signals in a radiating environment.

A transmitted signal will reflect off buildings, vegetation, bodies of water, and large, solid surfaces, causing ghosts of the carrier (main or intentional) frequency to arrive at the receiver later than the carrier frequency.

Multipath signal issues are a liability for all radio systems except those without VOFDM or a feature to cancel or filter the late-arriving signals.

Embedded in the OFDM-modulated carrier frequencies are training tones. These allow multipath-channel compensation on a burst-by-burst basis. This is especially important on the uplink because each OFDM burst may be transmitted by a different subscriber unit (SU) over a different multipath channel. The overall effect of the VOFDM scheme is an RF system that is extremely resilient to multipath signals.

Multiple Access and Error Control Schemes

This section describes various multiple access techniques and error control schemes.

Channel Data Rate

Raw channel over-the-air data rates are 36, 24, 18, 12, 9, and 6 Mbps. Excluding physical layer overhead, the user rates are different for the downstream and upstream links. Downstream, these rates are 22.4, 17, 12.8, 10.1, 7.6, and 5.1 Mbps. Upstream, the rates are 19.3, 15.2, 11.4, 8.1, 6.2, 4.4, 4.2, 3.2, and 1.4 Mbps. Various combinations of these rates are supported, depending on the cell type.

These are configuration parameters that can be set and changed. Thus, if a customer requests an increased data rate service, the change can be made from the network operations center (NOC) without personnel having to visit the customer site.

The service provider can make this as simple or as complicated as desired. Thus, one service city can have all subscribers on a single data rate plan, while another city can offer time-of-day and day-of-week data rate premium services.

Downstream and Upstream User Bandwidth Allocation

Downstream and upstream user bandwidth can be assigned dynamically for session-based traffic or, during initial registration for best-effort Internet data access, based on service flows for each user.

Duplexing Techniques

Time-division duplexing and frequency-division duplexing are the two common techniques used for duplexing. There are challenges with each of the two approaches, related to implementation, flexibility, sensitivity, network synchronization, latency, repeaters, asymmetrical traffic, AGC, and the number of SAW filters, among others. After a study of the subject, it was decided that the TDD vs. FDD selection is not a simple decision to make—indeed, the advantage marks are relatively close to one another. However, having the benefit of the most recent information regarding the procurement of low-cost duplexors, development priority was given to FDD scheme.

TDD is a duplexing technique that utilizes time sharing to transmit and receive data in both directions. Each side is allotted a certain amount of time to transmit, generally in symmetric amounts. The TDD algorithms are embedded into each of the RF processor boards and are synched by protocol instruction when the units are first powered up. Commonly these synching protocols are updated on a routine basis.

In FDD, the total allocated spectrum of frequency is divided so that each end of the radio link can transmit in parallel with the other side. FDD is commonly divided equally, but it is not symmetric on many links.

Multiple Access Technique

User bandwidth allocation is carried out by means of a Medium Access Control (MAC) protocol. This protocol is based on the MAC portion of DOCSIS protocol developed by the Cable Labs consortium. The MAC protocol assigns service flows (SID) to each user; depending on the quality of service (QoS) requirements, the upstream MAC scheduler provides grants to fulfill the bandwidth needs. Similarly, the downstream bandwidth is divided between active users of unicast and multicast services.

Each upstream channel is divided into intervals. Intervals are made up of one or more minislots. A minislot is the smallest unit of granularity for upstream transmit opportunities.

Upstream transmit opportunities are defined by the MAC MAP message. This message is sent from the base station to all registered CPEs. In the MAP message, each interval is assigned a usage code that defines the type of traffic that can be transmitted during that interval, as well as whether the interval is open for contention by multiple CPEs or for the sole use of one CPE. The interval types are request, request/data, initial maintenance, station maintenance, short data grant, long data grant, and acknowledgment.

For example, the request interval is used for CPE bandwidth requests and is typically multicast to all CPEs; therefore, it is an interval open for contention. Multiple CPEs can attempt to send a bandwidth request; if the request is granted, the base station will assign a series of minislots to the CPE in the next MAP message. Contention is resolved via a truncated binary exponential back-off algorithm.

Figure 20-14 Frame Allocation MAP

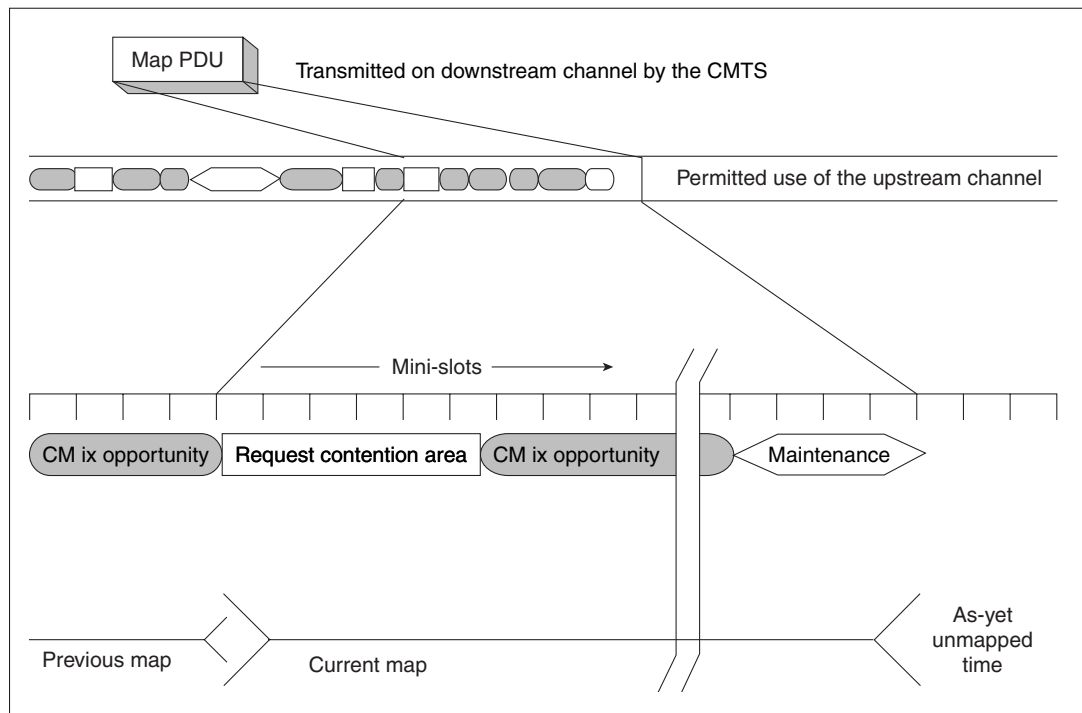

78699

To support customer QoS requirements, six types of service flows are specified: Unsolicited Grant Service (UGS), real-time Polling Service (rtPS), Unsolicited Grant Service with Activity Detection (UGS-AD), non-real-time Polling Service (nrtPS), Best Effort (BE) Service, and a Committed Information Rate (CIR) Service.

Unsolicited Grant Service

The intent of *UGS* is to reserve fixed-size data grants at periodic transmission opportunities for specific real-time traffic flows. The MAC scheduler provides fixed-size data grants at periodic intervals to the service flow. The QoS parameter for the given service flow sets the grant size, the nominal grant interval, and the tolerant grant jitter.

Real-Time Polling Service

The intent of the *rtPS* grants is to reserve upstream transmission for real-time traffic flows such as VoIP. Such service flows receive periodic transmission opportunities regardless of network congestion, but they release their transmission reservation when they are inactive. As such, the base station MAC scheduler sends periodic polls to *rtPS* service flows using unicast request opportunities enabling subscriber wireless port to request for the upstream bandwidth that it needs. The QoS parameter for such a service flow is nominal polling interval and the jitter tolerance for the request/grant policy.

Unsolicited Grant Service with Activation Detection

The intent of *UGS-AD* is to reserve upstream transmission opportunities for real-time traffic flows such as VoIP with silence suppression. *UGS-AD* is designed to emulate the capabilities of *UGS* service when active, and *rtPS* service when inactive. The QoS parameter for such a service flow is nominal polling interval, tolerated polling jitter, nominal grant interval, tolerated grant jitter, unsolicited grant size, and the request/transmission policy.

Non-Real-Time Polling Service

The intent of *nrtPS* is to set aside upstream transmission opportunities for non-real-time traffic flows such as FTP transfer. These service flows receive a portion of transmission opportunities during traffic congestion. The base station MAC scheduler typically polls such service flows either in a periodic or a nonperiodic fashion. The subscriber wireless port can use either the unicast request opportunities or contention request opportunities to request upstream grants. The QoS parameter for such a service flow is nominal polling interval, reserved minimum traffic rate, maximum allowed traffic rate, traffic priority, and request/transmission policy.

Best Effort Service

The intent of the *BE* service is to provide an efficient way of transmission for best-effort traffic. As such, the subscriber wireless port will use either contention or unicast request opportunities to request upstream grants. The QoS parameter for such a service flow is reserved minimum traffic rate, maximum sustained traffic rate and traffic priority.

Committed Information Rate

CIR can be implemented in several different ways. As an example, it could be a *BE* service with a reserved minimum traffic rate, or *nrtPS* with a reserved minimum traffic rate.

Frame and Slot Format

The frame and slot format is based on the MAC protocol. The downstream transmission is broadcast, similar to Ethernet, with no association with framing or a minislot. The recipients of downstream packets perform packet filtering based on the Layer 2 address—the Ethernet MAC or SID value.

The upstream transmission is based on a time-division multiple access (TDMA) scheme, and the unit of time is a minislot. The minislot size varies based on upstream configuration settings and can carry data between 8 bytes and approximately 230 bytes. TDMA synchronization is done by time-stamp messages, and the time of transmission is communicated to each subscriber by the MAP messages (a MAP message carries the schedule information (map) for each minislot of the next data protocol data unit (PDU)). MAP messages are initiated by the MAC scheduler in the base station and thus convey how each minislot is used (reserved for user traffic, for initial invitation, or as contention slots). The contention slots are used for best-effort traffic to request bandwidth from the scheduler. The frame time is programmable and can be optimized for a given network.

Synchronization Technique (Frame and Slot)

Accurately receiving an orthogonal frequency-division multiplexing (OFDM) burst requires burst timing and frequency offset estimation. Burst timing means determining where in time the OFDM burst begins and ends. Determining the difference between the local demodulating oscillator and the modulating oscillator at the transmitter is called frequency synchronization, or frequency offset estimation.

Burst timing and frequency offset are determined simultaneously through the use of the extra-cyclic-prefix samples in every downstream OFDM burst. Regardless of the channel, the samples in the extra-cyclic-prefix will be equal to a set of time-domain samples in the OFDM burst. This structure is optimally exploited to simultaneously identify the correct OFDM burst timing and frequency offset. These estimates are then filtered over successive OFDM bursts.

Burst timing and frequency synchronization are required for the downstream link. The upstream link will be frequency locked once the subscriber unit frequency locks the downstream signal. That is, the local oscillator at the subscriber unit is synchronized to the base station oscillator by use of a frequency-locked loop. In this way, the upstream transmission that arrives at the base station receiver will have nearly zero frequency offset.

As in any TDMA upstream, each subscriber unit must lock to the TDMA slot when transmitting on the upstream. This is referred to as ranging each subscriber. As prescribed by the MAC layer, a subscriber fills periodic ranging slots with a known sequence. This known sequence is used at the base station to determine proper slot timing.

The upstream TDMA synchronization is done via time-stamp messages that carry the exact timing of the base station clock. Each subscriber phase locks its local clock to the base station clock and then synchronizes its minislot (unit of TDMA) counter to match that of the base station. Furthermore, ranging is performed as part of initial acquisition to advance the transmission time of the subscriber so that the precise arrival of its transmission is synchronized with the expected minislot time of the base station.

Average Overall Delay over Link

The average overall delay in the link depends on the particular bandwidth and spectral efficiency setting. In all cases, the physical layer delay is limited to 5 ms in the downstream. The upstream physical layer delay is less than 2 ms.

Power Control

Power control is done in real time to track rapidly changing environment. It is one facet of the system capability to adjust on a packet-by-packet basis.

The power control is capable of adjusting for fades as deep as 20 dB.

Receiver signal power at the subscriber is controlled through the use of an *Automatic Gain Control (AGC)* system. The AGC system measures received power at the analog-to-digital converter (ADC) and adaptively adjusts the analog attenuation. With AGC, channel gain variations on the order of 200 Hz can be accommodated without impacting the OFDM signal processing.

Receive power at the base station is regulated through the use of an *Automatic Level Control (ALC)* system. This system measures power levels of each subscriber and creates transmit attenuator adjustments at the subscriber so that future communication is done with the correct transmit power level. This power control loop is implemented in the physical layer hardware so as not to impact the MAC-layer performance.

Power measurements for the purposes of ALC occur on upstream traffic. Specific power bursts may be requested by the base station MAC to power control subscribers.

Admission Control

A new user is admitted to the system by means of a software suite. Components of this suite are User Registrar, Network Registrar, Modem Registrar, and Access Registrar.

User Registrar enables wireless network subscribers to self-provision via a web interface. Subscriber self-provisioning includes account registration and activation of the subscriber's CPE and personal computers over the wireless access network. User Registrar activates subscriber devices with account-appropriate privileges through updates to an LDAPv3 directory.

Network Registrar supplies DHCP and DNS services for the CPEs and personal computers. Network Registrar DHCP allocates IP addresses and configuration parameters to clients based on per-device policies, which are obtained from an LDAP directory. Network Registrar allocates limited IP addresses and default configuration parameters to inactivated devices, to steer users to the User Registrar activation page.

Modem Registrar adds TFTP and time services to Network Registrar for the CPEs. The Modem Registrar TFTP builds DOCSIS configuration files for clients based on per-CPE policies, which are obtained from an LDAP directory. Modem Registrar builds limited-privilege configuration files to inactivated CPEs.

Access Registrar supplies RADIUS services for the CPEs and the clients that are connected to the CPEs. Access Registrar RADIUS returns configuration parameters to NAS clients based on per-subscriber policies, which are obtained from an LDAP directory. Access Registrar returns limited-privilege NAS and PPP parameters to unregistered subscribers and to inactivated CPEs.

Requirement to Cell Radius

As stated previously, the system employs frequency-division duplexing (FDD). Unlike time-division multiplexing (TDD) systems, the equipment is not subject to cell radius limits. The only limitation to cell radius is that imposed by free space attenuation (FSA) of the radio signals. Timing limitations imposed by the MAC protocol on upstream and downstream channels would permit the cell radius to be beyond the radio horizon (FSA notwithstanding).

Unless the subscriber density is very low, as in rural areas, very large cells are not recommended because they may quickly become capacity-limited and are difficult to scale to meet the higher capacity demand.

Requirement for Frequency Reuse

Two architectures are described in this section. The first is a multicellular architecture, called the small-cell pattern. The second architecture is known as a single-cell architecture. The baseline small-cell architecture employs a 4×3 frequency reuse pattern. This means that a four-cell reuse pattern and three sectors are employed within each cell or base station (BS). Within a cellularized network, a hexagonal cell is tiled out to completely cover the service area. In our system, a four-cell tiling pattern is repeated over the service area. This tiling pattern puts a lower limit on the reuse distance, thereby controlling interference levels. Employing three sectors within each BS further reduces interference compared to omnidirectional antennae. A 4×3 reuse pattern works well for operations using obstructed (OBS) links. It uses a total of 24 channels: 12 channels downstream, plus 12 channels upstream.

Note that the number of MMDS channels used may be different than $12 + 12$ because the system supports channels narrower than 6 MHz. At any given BS, signals are received from subscriber units (SUs) over both OBS links and line-of-sight (LOS) links. In general, OBS links are attenuated at 40 dB/decade; that is, R^{-4} path loss. LOS links, however, propagate based on R^{-2} path loss. Thus, if an SU has a LOS link to its BS, it likely also has a LOS link to a reuse BS. To suppress cochannel interference from LOS links, horizontal and vertical polarization are alternatively used on reuse cells. This results in an overall reuse scheme of $4 \times 3 \times 2$ and (still) using a total of 24 channels. This reuse pattern can be continued to cover as large a geographical area as desired. Improved frequency reuse can occur when networks are of more limited extent. This is because there are fewer tiers of interfering cells. In these cases, greater C/I ratios are obtained, along with greater network capacity (given a fixed amount of spectrum).

Our approach to frequency reuse for OBS links is conservative in that it does not rely on polarization discrimination. Signals transmitted over multipath channels often experience depolarization. If a dual polarization reuse scheme were employed, it may be very difficult to achieve 99.99 percent link availability because as a reuse (undesired) channel is depolarized, it results in higher levels of interference to the cochannel (desired) signal.

Radio Resource Management

Radio resource management falls under the following broad categories:

- Spectrum management in a cell
- Load balancing of CPEs within an upstream channel
- Time-slotted upstream architecture
- Contention resolution
- Traffic policing
- Traffic shaping
- Quality of service controls

Spectrum Management in a Cell

Within a cell, the upstream frequency band can be split into as many as four channels. The channel bandwidths that can be configured are 1.5 MHz, 3 MHz, and 6 MHz. The downstream frequency consists of one channel that again can be configured as one of 1.5, 3, or 6 MHz. The capability of the Cisco wireless products to operate in these wide ranges of channel bandwidths allows the operator great flexibility in designing the network for efficient usage.

Load Balancing of CPEs Within an Upstream Channel

A cell within the Cisco wireless access architecture consists of a downstream channel with up to four upstream 1.5-MHz channels. By default, load balancing is performed on the upstream channels as CPEs enter the network. Special algorithms run on CPE and the head end to ensure a uniformity of CPE loading on the upstream channels. This allocation of CPEs across the upstream channels can also be done under user control.

Time-Slotted Upstream

Cisco's wireless access solution uses a MAC protocol based on DOCSIS. This protocol is based on a broadcast downstream architecture and a time-slotted upstream architecture. The time slots for the upstream govern the access rights of each CPE on to the upstream channel. There is a very sophisticated scheduler that runs on the head end and allocates these time slots to all the CPEs. Resource sharing of the upstream bandwidth is realized by each CPE making its request to send in a contention time slot, the head end responding to it in a subsequent message downstream (called a MAP message), and the CPE using the information in the MAP message to send the data in an appropriate time slot upstream.

Contention Resolution

The DOCSIS protocol uses the notion of contention time slots in the upstream. These time slots are used by the CPEs to send a request to the head end for a time slot grant to send data. In a loaded upstream network, it is possible for these contention slots to become very congested themselves and nonproductive. Cisco's wireless head end uses an intelligent algorithm to ensure that the contention slots are evenly spaced, especially in times of high upstream load. The CPEs also implement an intelligent algorithm that ensures that the request grants from the CPEs are spaced evenly over all the contention slots in a given MAP message.

Traffic Policing

One of the most important features of the wireless access channel is its shared nature. At any given time, several hundreds or thousands of CPE subscribers may be sharing an upstream or downstream channel. Although this shared nature is useful for reducing the per-subscriber investment for the operator, two important aspects must be considered while providing this access service:

- The need to allocate this bandwidth fairly among all the users
- The need to prevent misbehaving users from completely monopolizing the access

The Cisco solution uses sophisticated algorithms at the head end to police the traffic from each subscriber CPE.

Traffic Shaping

The traffic from each CPE can also be shaped by algorithms running at the head end. This allows the operator to provision services to the CPE based on the critical nature of the traffic, customer needs, and so on. The peak rates of traffic from each subscriber are measured on a continuous basis and are policed at every request from the CPE. If the request from the CPE exceeds its allotted rate, the grant is delayed, thereby effectively controlling the rate of data transfer from the CPE. Differentiated services can be offered to subscribers. The operator can configure different maximum data rates for different wireless subscribers and can charge accordingly. Subscribers requiring higher peak rates and willing to pay for the same can be configured with a higher peak rate limit dynamically or statically.

Interface Specifications Based on the Generic Reference Model

We will use the generic reference model in Figure 20-15. In this figure, reference points I-VIII refer to specific interfaces and/or functions. We describe each of these interfaces or functions below.

Figure 20-15 Generic Reference Model for Broadband Wireless Access

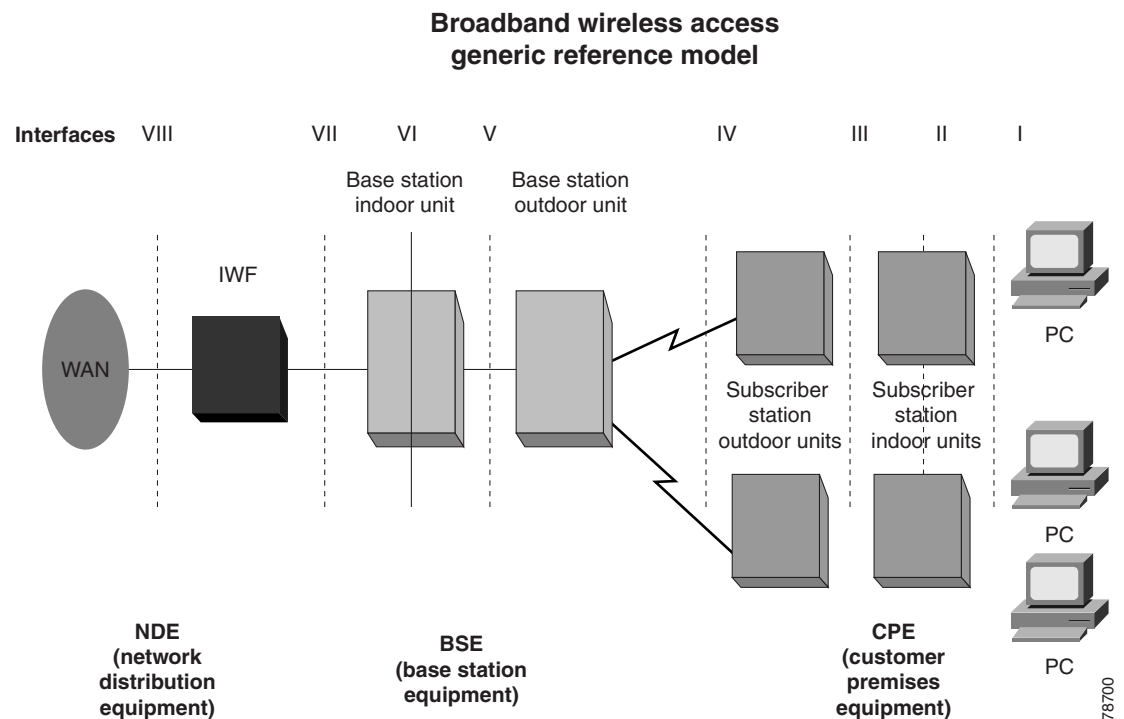

- Interface I: Wireless Subscriber Interface
- Interface II: Subscriber Indoor Unit PHY/MAC Interface
- Interface III: Subscriber Radio IF/RF Interface—This interface is a physical coaxial cable carrying IF, digital control information, and DC powering for the ODU.
- Interface IV: RF Air Interface—This interface is the over-the-air RF interface. It is in the MMDS frequency band (2.500 to 2.690 GHz, and 2.150 to 2.162 GHz). The energy radiated from the antenna is governed by *FCC Rules and Regulations, Part 21*.

The above descriptions of interfaces I to III represent Cisco Systems products by way of example. Such products will interwork with the base station described next, via interface IV compatibility, but will have many new and different CPE interfaces, features, and services.

- Interface V: Base Station RF/IF Interface—This interface at the base station is a physical coaxial cable carrying intermediate frequency (IF), digital control information, and DC powering for the outdoor unit (ODU).
- Interface VI: Base Station Indoor PHY/MAC Interface—This interface is internal to the Cisco router.
- Interface VII: Network Connection Interface

Wireless Protocol Stack

The access wireless architecture consists of a base station system that serves a community of subscriber systems. It is a point-to-multipoint architecture in the sense that the entire bandwidth on the upstream and downstream is shared among all the subscribers. The protocol stack implemented to make all this work is based on the DOCSIS standards developed by the Cable Labs consortium.

The current state of the art is the version by Cisco that includes a base station end (a UBR7200 router); the subscriber end is in the 3600 or a 900 router series. The base station end and the subscriber end operate as forwarding agents and also as end systems (hosts). As forwarding agents, these systems can also operate in bridging or routing mode. The principal function of the wireless system is to transmit Internet Protocol (IP) packets transparently between the base station and the subscriber location. Certain management functions also ride on IP that include, for example, spectrum management functions and the software downloading.

Both the subscriber end and the base station end of the wireless link are IP hosts on a network, as shown in Figure 20-16, and they fully support standard IP and Logical Link Control (LLC) protocols, as defined by the IEEE 802 LAN/MAN Standards Committee standards. The IP and Address Resolution Protocol (ARP) protocols are supported over DIX and SNAP link layer framing. The minimum link layer minimum transmission unit (MTU) on transmit from the base station is 64 bytes; there is no such limit for the subscriber end. IEEE 802.2 support for TEST and XID messages is provided.

The primary function of the wireless system is to forward packets. As such, data forwarding through the base station consists of transparent bridging or network layer forwarding such as routing and IP switching. Data forwarding through the subscriber system is link layer transparent bridging as with Layer 3 routing based on IP. Forwarding rules are similar to [ISO/IEC10038], with modifications as described in DOCSIS specifications Section 3.1.2.2 and Section 3.1.2.3. Both the base station end and the subscriber end support DOCSIS-modified spanning-tree protocols and include the capability to filter 802.1d bridge PDUs (BPDUs). The DOCSIS specification also assumes that the subscriber units will not be connected in a configuration that would create network loops.

Both the base station end and the subscriber end provide full support for Internet Group Management Protocol (IGMP) multicasting.

Above the network layer, the subscribers or end users can use the transparent IP capability as a bearer for higher-layer services. Use of these services will be transparent to the subscriber end and the base station end.

In addition to the transport of user data, several network management and operation capabilities are supported by the base station end and the subscriber end:

- Simple Network Management Protocol (SNMP), [RFC-1157], for network management
- Trivial File Transfer Protocol (TFTP), [RFC-1350], a file transfer protocol, for downloading software and configuration information, as modified by RFC 2349, “TFTP Timeout Interval and Transfer Size Options” [RFC-2349]

- Dynamic Host Configuration Protocol (DHCP), [RFC-2131], a framework for passing configuration information to hosts on a TCP/IP network
- Time of Day Protocol [RFC-868], to obtain the time of day

Figure 20-16 Wireless Protocol Stack for Network Management and Operation

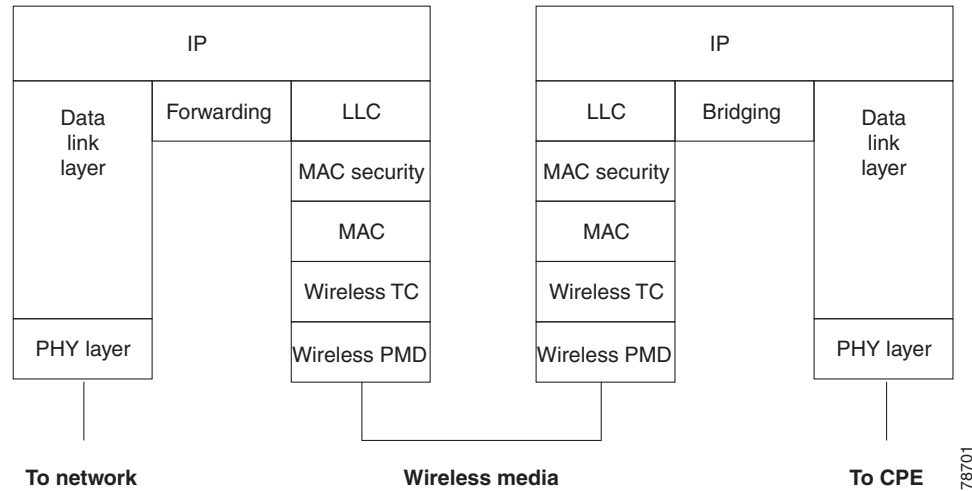

Link layer security is provided in accordance with DOCSIS baseline privacy specifications.

System Performance Metrics

Table 20-4 shows the network capacity for High Capacity Suburban/Urban Small-Cell Network.

Table 20-4 Network Capacity for High-Capacity Suburban/Urban Small-Cell Network

Cell Radius (Mile)	No. of Cells	Small Businesses Served	Small Business Penetration	Households Served	Household Penetration
2.2	83	5,229	10.5%	126,990	15.9%

These capacities are based on 6-MHz downstream channels and 3-MHz upstream channels:

- **Downstream**—6 MHz; at the medium VOFDM-throughput setting, 17.0 Mbps.
- **Upstream**—3.0 MHz; at the low VOFDM-throughput setting, 4.4 Mbps. The low setting has been chosen so that both SB and residential SUs may be serviced by the same upstream channels.

This high-capacity network has 83 cells in the network, each with 3 sectors. A total of 249 sectors are in the network, each serving 21 SB and 510 HH. Overall, a total of 249 × 21, or 5,229, SBs are served by the network; similarly, a total of 126,990 HHs are served.

This network design graphically illustrates the power and scalability of Cisco’s technology.

Supercell Network Design

The supercell (very large cell) network design is one that provides low coverage and low overall network capacity. However, it may be attractive for initial network rollout because of the availability of existing (tall) towers. In our supercell design, assuming that a sufficient number of MMDS channels are available, up to 18 sectors may be used. No frequency reuse is performed within the supercell, again because of sector-to-sector isolation requirements that are greater than sector antennae can provide. Each sector operates independently. Also, at least four MMDS-channels must be set aside as guard bands.

The number of sectors deployed on the supercell may be scaled as the demand for capacity grows. Because there is no frequency reuse, no special requirements are placed on the design of the sector antennae. For example, the same panel antenna used for a 3-sector supercell could also be used all the way up to 18 sectors. However, to increase RF coverage, narrower-beam antennae may be employed to increase EIRP. This will be effective as long as the supercell isn't capacity-limited (which is often the case).

The capacity of the supercell is given in Table 20-5. In this deployment model, we have not differentiated between suburban and urban deployments. The assumption is that the desire is to provide service primarily to subscribers in which LOS operation is possible. Because macrodiversity is not possible in a supercell design, coverage becomes difficult. For example, the COST-231 Hata model predicts an 80 percent coverage at a radius of only 15 miles—much smaller than the desired cell radius. Moreover, this coverage is computed at the limits of the model's antenna heights—200 m for the HE, and 10 m for the SU over suburban terrain.

Table 20-5 Network Capacity for Supercell

Number of Sectors	Cell Radius (Mile)	Small Businesses Served	Small Business Penetration	Households Served	Household Penetration
3	16	1,116	2%	26,856	3%
18	23	2,232	4%	53,712	7%

These capacities are based on 6-MHz downstream channels and 3-MHz upstream channels, both at the medium VOFDM-throughput setting.

If a lower availability objective were desired, the fade margin could be greatly reduced, thereby extending the cell radius. More importantly, the sector-to-sector isolation would be greatly reduced, perhaps admitting frequency reuse within the supercell. Because the cell is capacity-limited (there are many more subscribers in the cell's radio footprint than there is capacity to service), this would be a tremendous benefit.

The multipath channel from both the front (desired) antenna and the rear (undesired) antenna must be the same so that the fading from the desired and undesired antennae must be highly correlated.

The time rate-of-change of the multipath channel must be slow enough such that power control errors are very small.

The following sections present both the general functions performed by the various configuration items or building blocks segmented into transport and services products.

Transport Layer Products

The transport layer is composed of the equipment that provides the transmission and reception of IF signals between the rooftop and router equipment and the RF signals over the air. The transport equipment is designed to work in an outdoor environment mounted on buildings or telecommunications towers. The P2MP transport layer is physically segmented into hub and terminal equipment categories, as depicted in Figure 20-17.

Figure 20-17 Hub Site Equipment (Per Sector)

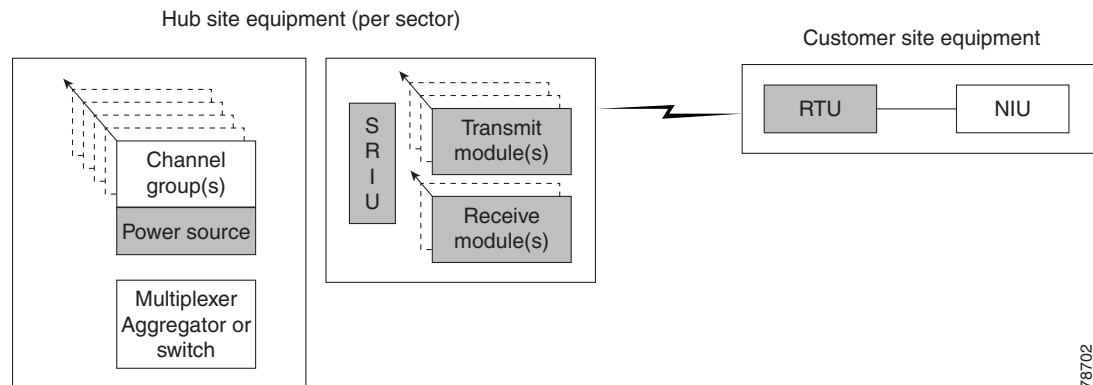

P2MP Transport Equipment Element—Customer Premises

The terminal equipment consists of an integrated RF transceiver/antenna, commonly referred to as the *rooftop unit (RTU)*. This equipment is easily installed on any customer rooftop using a standard mounting device. The RTU requires two RG-11 coaxial cables to the indoor equipment for transmit, receive, and power. The RTU operates on 12.5VDC (nominal) at the input and in standard configuration must be installed within 60 m of the network interface unit (NIU), although longer spans can be engineered and supported.

Rooftop Unit

The sole element of the P2MP transport layer at the terminal site is the RTU. The RTU is an integrated antenna and RF transceiver unit that provides wireless transmission and reception capabilities in the 5.7 GHz frequency region. Received and transmitted signals are frequency translated between the 5.7 GHz region and an intermediate frequency (IF) in the 400 MHz range to the network interface unit (NIU).

The RTU consists of an antenna(s), a down-converter/IF strip, and an up-converter/transmitter. It receives/transmits using orthogonal polarization. Selection of polarization (horizontal/vertical) occurs at installation and is dictated by the hub-sector transmitter/receiver. This selection remains fixed for the duration that service is provided to that site.

The RTU mounts on the exterior of a subscriber's building. Some alignment is required to gain line of sight (LOS) to the hub serving the RTU. Multiple RTUs can be deployed to provide path redundancy to alternate hub sites. The RTU requires dual coax cable (RG-11) runs to the NIU for signal and power. The maximum standard separation between the RTU and the NIU is 60 m. This separation can be extended via application-specific designs.

Basic Receiver

A single basic receiver is required per 90° sector, if no return-path redundancy is required. The receive module is an integrated 5.7-GHz receiver/down-converter/antenna. A collection of signals is received from customer units operating in the 5.7 GHz band and is block down-converted to an intermediate frequency signal. This signal is provided to any of the channel group types. Vertical or horizontal polarization is selectable, and a redundant receiver per sector can be deployed as an option.

High-Gain Receiver

A high-gain receiver is used in lieu of the basic receiver when higher link margin is required because of the specific geographic conditions of deployment. The high-gain receive module is intended to be matched only with the high-gain transmit module. The specifications are identical to those of the basic receive module, except for physical package and antenna gain.

Because of the modularity of the SP2200 products, there is no one standard rack or set of racks. All SP2200 elements are designed to mount in a standard 19-inch (48.3-cm) open relay rack with a standard EIA hole pattern or an equipment enclosure with 19 inches (48.3 cm) of horizontal equipment mounting space. Final assembly of the equipment into racks is accomplished on site at initial install or over time as capacity demands.

LMDS Environmental Considerations

Environmental conditions such as rain and smog must be considered when deploying RF systems that transmit at frequencies above 10 GHz because these conditions degrade the signal path and shorten the maximum range for a given data link.

LMDS data links are generally about one-fourth that of MMDS or U-NIII links and require fairly strict adherence to a line-of-sight implementation. One of the more favorable aspects of the LMDS frequency, however, is that it has exceptional frequency reuse capabilities.

Data link availability is expressed in terms of the number of nines that follow the decimal point. For example, 99.999 percent link availability means that a data link will be up and online (available) for all but .001 percent of the year. Link availability is dependent on a wide range of items, but these generally begin with fundamental RF system design issues such as antenna size, range between antennae, and atmospheric conditions (for LMDS band).

WLAN Standards Comparison

Table 20-6 provides a brief comparison of WLAN standards.

Table 20-6 A Brief Comparison of HomeRF, Bluetooth, and 802.11 WLAN Standards

	HomeRF	Bluetooth	802.11
Physical Layer	FHSS ¹	FHSS	FHSS, DSSS ² , IR ³
Hop Frequency	50 hops per second	1600 hops per second	2.5 hops per second
Transmitting Power	100 mW	100 mW	1W
Data Rates	1 or 2 Mbps	1 Mbps	11 Mbps

Table 20-6 A Brief Comparison of HomeRF, Bluetooth, and 802.11 WLAN Standards (continued)

	HomeRF	Bluetooth	802.11
Max # Devices	Up to 127	Up to 26	Up to 26
Security	Blowfish format	0-, 40-, and 64-bit	40- to 128-bit RC4
Range	150 feet	30 to 300 feet	400 feet indoors, 1000 feet LOS
Current Version	V1.0	V1.0	V1.0

1. FHSS—frequency hopping spread spectrum
2. DSSS—direct sequence spread spectrum
3. IR—infrared

The following should be noted in Table 20-6:

- 40- to 128-bit RC4 refers to very robust data security algorithms.
- An 802.11 range of 1,000 feet refers to outdoor conditions. Indoor conditions are more difficult for these types of RF systems.
- 802.11 power output of 1W is substantial.
- The maximum number of devices supported depends on data rate per device.
- The Aironet acquisition uses 802.11.

Although there are three standards in use in the United States, and an additional two are in use in Europe (HyperLAN and HyperLAN2), the FCC thinks highly of the 802.11b standard, and a close relationship exists between the FCC and the IEEE, which backs the standard.

Summary

At least 18 different types of wireless are in commercial use today. Therefore, as this technology becomes more mainstream, users will need to be increasingly specific in their reference to the term. The different types of wireless are quite unique to each other on numerous levels, and they require specific types of expertise to deploy, use, and maintain.

In its state-of-the-art deployment, a wireless link emulates all the capabilities of a fully featured router, which means that a wireless link can provide VPN, enterprise toll bypass, and MDU/MTU access services. This is one of the primary differences between a Layer 2 product as provided by the majority of wireless vendors and the Layer 3 solution provided by Cisco Systems.

Regardless of the provider of a wireless system, the fundamental elements remain relatively constant:

- Data or network
- Edge or access router
- DSP medium
- RF medium (coax, modulator/demodulator, antenna)
- RF management software

Like every access medium or technology, wireless has its pros and cons. The pros include these:

- It's much less expensive to deploy than trenching for cabling.
- It's much quicker to deploy—a link can be up in a couple of hours.

- Wireless can go where cables can't, such as mountainous or inaccessible terrain.
- Less red tape is involved for deployment, if roof rights or elevation access is available.
- It involves an inherent high degree of security, and additional security layers can be added.
- Wireless provides broadband mobility, portability that tethered access doesn't provide.

Review Questions

Q—*What is the primary difference between narrowband and broadband wireless?*

A—Broadband wireless offers bandwidth in excess of 1.5 Mbps.

Q—*What is the primary difference between WLAN and fixed wireless?*

A—WLAN enables the user mobility up to pedestrian speeds. Fixed wireless requires that both antennae remain stable and fixed in their positions.

Q—*Identify three different applications for wireless.*

A—LAN, backhaul, toll bypass, and VPNs.

Q—*What are the fundamental hardware elements of a wireless solution?*

A—Data or network, edge or access router, DSP medium, RF medium (coax, modulator/demodulator, antenna).

Q—*What are the primary benefits of wireless?*

A—Wireless is much less expensive to deploy than trenching for cabling; is much quicker to deploy because a link can be up in a couple of hours; can go where cables can't, such as in mountainous or inaccessible terrain; involves less red tape for deployment; and comes with an inherent high degree of security. In addition, wireless provides broadband mobility—portability that tethered access doesn't provide.

For More Information

- <http://winwww.rutgers.edu/pub/Links.html> (Wireless links)
- <http://home.earthlink.net/~aareiter/introto.htm> (Guide to wireless Internet)
- <http://www.airlinx.com/products.htm> (RF product menu)
- <http://www.allnetdevices.com/news/index.html> (allNetDevices news)
- http://www.americasnetwork.com/issues/97issues/971001/100197_futurebb.html (Broadband's evolution)
- <http://www.broadbandforum.com> (Cable Broadband Forum)
- <http://www.businesswire.com/cnn/wcii.htm> (WinStar press releases)
- <http://www.comet.columbia.edu/~angin/e6950/coolites.html> (Wireless topics home page)
- <http://www.ctimag.com/> (CTI newsletter)
- http://www.data.com/tutorials/web_connection.html (Wireless web tutorial)
- <http://www.dectweb.com/sitemap.htm> (DECTweb)
- <http://www.dnspublishing.com/rc/rcindex.cfm> (Reciprocal Compensation site)
- <http://www.ericsson.com/BN/dect2.html> (Ericsson DECT)

- http://www.fcc.gov/Bureaus/Common_Carrier/Reports/FCC-State_Link/recent.html (FCC carrier data)
- <http://www.fiberopticsonline.com> (*Fiberoptics Online*)
- <http://www.gbmarks.com/wireless.htm> (Goodman's Wireless Telecomm links)
- <http://www.globalwirelessnews.com/> (RCR Global Wireless news)
- <http://www.herring.com/mag/issue48/comm.html> (Ericsson's broadband plans)
- <http://www.hometoys.com/htinews/oct99/articles/allied/allied.htm>
- http://http.cs.berkeley.edu/~gribble/cs294-7_wireless/summaries/index.html (UC Berkeley course in wireless)
- <http://www.internettelephony.com> (Internet telephony)
- <http://www.internettelephony.com/archive/featurearchive/7.06.98.html> (FSAN overview)
- <http://www.it.kth.se/edu/gru/Fingerinfo/telesys.finger/Mobile.VT96/DECT.html> (DECT)
- <http://www.itu.int/imt/2-radio-dev/proposals/index.html> (ITU world radio standards)
- <http://www.mobilecomputing.com/> (Mobile Computing & Communications)
- <http://www.phonezone.com/tutorial/nextgen.htm> (Next-generation phone systems)
- <http://www-star.stanford.edu/~osama/links.html> (Single-chip 2.4GHz radio)
- http://www.tek.com/Measurement/App_Notes/ap-Wireless/welcome.html (Wireless digital modulation)
- <http://www.telecomweb.com/ct/> (*Communications Today*)
- <http://www.ti.com/sc/docs/wireless/cellterm.htm> (Glossary of wireless terms)
- <http://www.ti.com/sc/data/wireless/panos1.pdf> (Wireless systems and technology overview)
- <http://www.tiap.org> (Guide to evolving wireless services)
- <http://www.tr.com/> (Telecommunications Reports)
- <http://www.trio.ca/annual/thrusts/mobsat.htm> (Ontario, Canada, wireless and mobile research)
- <http://www.wapforum.org/what/technical.htm> (WAP Forum specs)
- http://www.webproforum.com/wpf_wireless.html (Wireless tutorials)
- <http://www.wirelessdata.org> (Wireless Data Forum)
- <http://www.wirelessdata.org/news/currenttxt.asp> (Current newsletter)
- <http://www.wirelessdesignonline.com> (Wireless Design Online)
- <http://www.wirelessweek.com/industry/indtoc.htm> (*Wireless Week* industry information and statistics)
- <http://www.wow-com.com/index.cfm> (CTIA wireless web page: World Of Wireless)
- <http://www.wow-com.com/wirelessurvey/1298datasurvey.pdf> (1998 U.S. Wireless Survey)
- http://www.zdnet.com/anchordesk/story/story_1384.html (Survey of access technologies by ZD AnchorDesk)
- <http://www.zdnet.com/intweek/print/971013/158897.html> (October 1997 survey of access technologies)

Regulation and Government

- <http://www.broadband-guide.com/lw/reg/index.html> (Pennwell pubs)

- http://www.commnw.com/3rd_Generation.html (Article about TR-45 workshop on IMT-2000)
- <http://www.fcc.gov/bandwidth/> (FCC bandwidth home page)
- <http://www.itu.ch/imt/> (International Mobile Telecommunications–2000 [ITU R/T Initiative])
- <http://www.ntia.doc.gov/osmhome/allochrt.html> (U.S. Spectrum chart)

WLL

- <http://www.analysys.co.uk/publish/registered/locloop/default.htm#contents> (LL competition)
- <http://www.globaltelephony.com/archives/GT598/GT598cover.html> (WLL cover feature)
- <http://www.internettelephony.com/content/html/focus/feature1.html> (Feb 1998 Next-generation WLL)
- <http://www.isir.com/wireless/> (WLL world)
- <http://www.ntia.doc.gov/forums/wireless/index.html> (WLL forum)
- http://www.verticom.com/cieee_1/index.htm (Steve Goldberg's IEEE talk on Wireless LL)
- <http://www.wavespan.com/solutions/ultraman.shtml> (Wavespan Stratum 100)

LMDS/MMDS (Wireless Cable)

- <http://businesstech.com/telecom/btfreetelecom9902.html> (History of MMDS)
- <http://grouper.ieee.org/groups/802/16/> (IEEE 802.16 BroadBand Fixed Wireless home page)
- http://nwest.nist.gov/tutorial_ets.pdf (A good LMDS context briefing)
- <http://nwest.nist.gov/> (Click on News for current standards activity)
- http://www.americasnetwork.com/issues/98issues/980801/980801_lmlds.html
- http://www.americasnetwork.com/issues/99supplements/990601lmlds/990601_toc.htm
- <http://www.cabledatcomnews.com/wireless/cm12.html> (North American MMDS trials)
- <http://www.fcc.gov/Bureaus/Wireless/Factsheets/lmlds.html> (FCC fact sheet on LMDS auction results)
- <http://www.nmcfast.com> (IBM and NewMedia partner in MMDS)
- <http://www.teledotcom.com/1097/features/tdc1097telcos.html> (BellSouth MMDS writeup)
- <http://www.WCAI.com/index.htm> (The WCA's home page for the Wireless Cable Association)
- <http://www.webproforum.com/nortel4/> (Nortel tutorial on LMDS)
- <http://www.zdnet.com/intweek/print/970630/inwk0009.html> (Broadband wireless alternatives)

Cordless

- <http://www.broadband-guide.com/wi/techupdate/techupjf98.html> (Wireless in-building telephone systems)

Satellite

- <http://sat-nd.com/news/> (Satellite news)
- <http://tcpsat.grc.nasa.gov/tcpsat/> (TCP over Satellite WG)
- <http://www.data.com/issue/990707/satellite.html> (Internet satellite links)
- <http://www.ee.surrey.ac.uk/Personal/L.Wood/constellations/> (The orbits)
- <http://www.herring.com/mag/issue48/space.html> (Loral portrait)
- <http://www.iridium.com/index.html> (Iridium home page)

- <http://www.msua.org/mobile.htm> (Mobile Satellite Users Association)
- <http://www.project77.com> Project77 (Iridium pricing)
- <http://www.satphone.com/> (Overview of programs)
- <http://www.satphone.net> (Iridium Service Provider Satellite Warehouse)
- <http://www.skybridgesatellite.com/> (SkyBridge)
- <http://www.skyreport.com/> (Research and reporting for the satellite industry)
- <http://www.spotbeam.com/links.htm> (Internet, satellite links)
- <http://www.spotbeam.com/mansum.htm> (GEO summary)
- <http://www.spotbeam.com/mansum99.htm> (Internet and ISP summary)
- <http://www.techweb.com/se/directlink.cgi?NWC19980315S0017> (Broadband Ka satellites)
- <http://www.techweb.com/se/directlink.cgi?NWC19980315S0011> (Satellite insecurity)
- <http://www.wizard.net/~vvaughn/sat.htm> (Satellite voice system comparisons)

Modulations

- <http://diva.eecs.berkeley.edu/~linnartz/MCCDMA.html> (OFDM definitions)
- <http://propagation.jpl.nasa.gov/propdb/HELP/CLOUD.HTM> (Effects of clouds and rain)
- <http://sss-mag.com/favlinks/index.html> (Many modulation links)
- <http://wireless.stanford.edu/research.html> (Stanford University wireless research)
- <http://www.catv.org/modem/technical/ofdm.html> (OFDM, the next upstream modulation)
- <http://www.ee.mtu.edu/courses/ee465/groupe/index.html> (CDMA class)
- http://www.gr.ssr.upm.es/~ana/ofdm_links.htm (OFDM sites)
- <http://www.sm.luth.se/csee/sp/projects/ofdm/ofdm.html> (OFDM description)

Interfaces

- <http://cx667314-a.chnd1.az.home.com/1394Informer/990800.htm> 1394 (News home page)
- <http://skipstone.com/compcn.html> (IEEE 1394 overview)
- <http://www-europe.cisco.com/warp/public/459/8.html> (HSSI)
- <http://www.mfsdatanet.com/mfs-international/hssi.html> (HSSI)
- <http://www.sdlcomm.com/> (HSSI PCI module)

Glossary Terms

The following list of terms was selected by their frequency of use when discussing Cisco wireless interests. This list should not be considered comprehensive with respect to the wireless industry in general. Furthermore, certain aspects of these acronyms remain in a state of flux and should be considered accurate per the date of this document.

- **adjacent channel**—A channel or frequency that is directly above or below a specific channel or frequency.
- **amplitude**—The magnitude or strength of a varying waveform. Typically, this is represented as a curve along the x-axis of a graph.

- **analog signal**—The representation of information with a continuously variable physical quantity, such as voltage. Because of this constant change of the wave shape as it passes a given point in time or space, an analog signal may have a virtually indefinite number of states or values. This contrasts with a digital signal, which is expressed as a square wave and therefore has a very limited number of discrete states.
- **antenna**—A device for transmitting or receiving a radio frequency (RF). Antennae are designed for specific and relatively tightly defined frequencies, and are quite varied in design. An antenna for a 2.5 GHz (MMDS) system will not work for a 28 GHz (LMDS) design.
- **antenna gain**—The measure of an antenna *assembly* performance relative to a theoretical antenna called an isotropic radiator (*radiator* is another term for *antenna*). Certain antenna designs feature higher performance relative to vectors or frequencies.
- **bandwidth**—The frequency range necessary to convey a signal measured in units of hertz (Hz). For example, voice signals typically require approximately 7 kHz of bandwidth, and data traffic typically requires approximately 50 kHz of bandwidth.
- **BTA**—Basic trading area; an area or footprint in which an entity is licensed to transmit its frequencies. BTAs were established by Rand McNally and are defined as county lines. Rand McNally licensed its mapping data to the FCC for ease of designation for site licenses.
- **broadband**—In general, an RF system is deemed broadband if it has a constant data rate at or in excess of 1.5Mbps. Its corresponding opposite is narrowband.
- **broadcast**—In general, this is the opposite of narrowcast and infers that a signal is sent to many points at the same time or is transmitted in an omnidirectional pattern.
- **CDMA**—Code division multiple access; a transmission scheme that allows multiple users to share the same RF range of frequencies. In effect, the system divides a small range of frequencies out of a larger set and divides the data transmission among them. The transmitting device divides the data among a preselected set of nonsequential frequencies. The receiver then collates the various data pieces from the disparate frequencies into a coherent data stream. As part of the RF system setup, the receiver components are advised of the scrambled order of the incoming frequencies. An important aspect of this scheme is that the receiver system filters out any signal other than the ones specified for a given transmission.
- **channel**—A communications path wide enough to permit a single RF transmission.
- **coax cable**—The type of cable used to connect Cisco equipment to antennae.
- **converter**—RF systems have two fundamental frequencies: that which is sent over the air (carrier frequency), and that which is sent back and forth between Cisco equipment and the antennae (intermediate frequency). This is performed by a converter; also known as up or down converters or transverters. The intermediate frequencies are split into a higher and lower frequency that is used for either transmission or reception of data between the antenna assembly and Cisco devices.
- **dB**—Decibel; a unit for measuring relative power ratios in terms of gain or loss. Units are expressed in terms of the logarithm to base 10 of a ratio and typically are expressed in watts. dB is not an absolute value—rather, it is the measure of power loss or gain between two devices. As an example, a –3 dB loss indicates a 50 percent loss in power, a +3 dB reading is a doubling of power. The rule of thumb to remember is that 10 dB indicates an increase (or loss) by a factor of 10. Likewise, 20 dB indicates an increase (or loss) of a factor of 100, and 30 dB indicates an increase (or loss) by a factor of 1000.

Because antennae and other RF devices/systems commonly have power gains or losses on the order of magnitude of 4, dB is a more easily used expression.

- **dB_i**—dB referenced to an isotropic antenna (hence the “i”) that is theoretically perfect in terms of symmetric patterns of radiation. Real-world antennae do not perform with even nominal amounts of symmetry, but this effect is generally used to the advantage of the system designer.

- **dBm**—dB referencing 1 milliwatt; 0 dBm is defined as 1 mW at 1 kHz of frequency at 600 ohms of impedance.
- **dBW**—dB referencing 1 watt.
- **demodulator**—A device for assembling signals after they have been received by an antenna. A demodulator is typically the first major device downstream from an antenna receiving system, and it exists on the block diagram before various Cisco devices. The corresponding device on the transmission side of a system is a modulator.
- **EIRP**—Effective isotropic radiated power; the term for the expression of the performance of an antenna in a given direction relative to the performance of a theoretical (isotropic) antenna. This is expressed in watts or dBW. EIRP is the sum of the power sent to the antenna plus antenna gain.
- **electromagnetic spectrum**—The full range of electromagnetic (same as magnetic) frequencies, the subset of which is used in commercial RF systems. Commercial RF systems are typically classified in ranges that include MF, HF, VHF, SHF, and EHF. Military systems typically include frequencies outside these types.
- **fixed wireless**—The type of Cisco wireless in which both the transmitter and the receiver are not mobile. Cisco wireless is always broadband wireless, with data rates in excess of 1.5 Mbps.
- **footprint**—The geographical area in which an entity is licensed to broadcast its signal.
- **frequency reuse**—One of the fundamental concepts on which commercial wireless systems are based. It involves the partitioning of an RF radiating area (cell) into segments of a cell—for Cisco purposes, this means that the cell is broken into three equal segments. One segment of the cell uses a frequency that is far enough away from the frequency in the bordering segment to provide interference problems. The same frequency is used at least two cells apart from each other. This practice enables cellular providers to have many times more customers for a given site license.
- **gain**—The ratio of the output amplitude of a signal to the input amplitude of a signal. This ratio is typically expressed in decibels. The higher the gain, the better the antenna receives or transmits, but also the more noise it includes.
- **license**—The purchased right to transmit RF waves over a BTA is typically given for a ten year period. The license tightly governs the design parameters of an RF system and its use. RF licenses are (typically) purchased from the FCC on an auction basis.

The FCC provides licenses to ensure maximum competition in a free market (although this is not always obvious in the way the FCC manages the auctions) and spectral efficiency, which is another way of stating efficient use of the RF spectrum.

- **LMDS**—Local Multipoint Distribution Service; a relatively low-power license for broadcasting voice, video, and data. Typically two licenses are granted in three frequencies each to separate entities within a BTA. These licenses are known as Block A or Block B licenses. Block A licenses operate from 27.5 to 28.35 GHz, 29.10 to 29.25 GHz, and 31.075 to 31.225 GHz, for a total of 1.159 MHz of bandwidth. Block B licenses operate from 31.00 to 31.075 GHz, and 31.225 to 31.300 GHz, for a total of 150 MHz of bandwidth. LMDS systems have a typical maximum transmission range of approximately 3 miles, as opposed to the transmission range of an MMDS system, which is typically 25 miles. This difference in range is primarily a function of physics and FCC-allocated output power rates.
- **LOS**—Line of sight; refers to the fact that there must be a clear, unobstructed path between transmitters and receivers. This is essential for LMDS products and enhances general performance in every RF deployment, compared to partial or completely obstructed data paths. The opposite of LOS is non-line-of-sight (NLOS).

- **MMDS**—Multichannel Multipoint Distribution Service; this is comprised of as many as 33 discrete channels that are transmitted in a pseudorandom order between the transmitters and the receivers. The FCC has allocated two bands of frequencies for each BTA—2.15 to 2.161 GHz, and 2.5 to 2.686 GHz.
- **mobile wireless**—Cisco does not provide mobile wireless components; instead, it provides backbone devices such as a GGSN that support mobile wireless infrastructures.
- **NLOS**—Non-line-of-sight; also known as obstructed path or pathway.
- **parabolic antenna**—A dishlike antenna that sends RF waves in a highly focused manner. Such antennae provide very large power gains and are highly efficient. This antenna is typical to Cisco's LMDS, U-NII, and MMDS systems, but this is not the only design available or appropriate for those frequencies.
- **path loss**—The power loss that occurs when RF waves are transmitted through the air. This loss occurs because the atmosphere provides a filtering effect to the signal. Certain electromagnetic frequencies (very high and noncommercial) are completely blocked or filtered by the atmosphere.
- **point-to-multipoint**—P2MP; generally infers the communication between a series of receivers and transmitters to a central location. Cisco P2MP is typically set up in three segments to enable frequency reuse. Cisco offers MMDS, U-NII, and LMDS systems in P2MP.
- **Point-to-point**—P2P; has a higher bandwidth than P2MP because, among other things, it has less overhead to manage the data paths and only one receiver exists per transmitter. Cisco offers MMDS, U-NII, and LMDS systems in P2P.
- **RF**—Radio frequency; generally refers to wireless communications with frequencies below 300 GHz.
- **TDMA**—Time-division multiple access; a technique for splitting transmissions into time slots, which enables a greater number of users for a given frequency. A technique commonly used, as opposed to CDMA.
- **U-NII**—Unlicensed National Information Infrastructure. Cisco offers a wireless product for this in the 5.7 GHz frequency. This frequency does not require the use or purchase of a site license, but, as with all electronic devices sold commercially, it does require registration with the FCC.
The *NII* is a term coined by federal regulators to describe the access of information to citizens and business. Equivalent to the term “information superhighway,” it does not describe system architecture or topology.
- **Wireless Access Protocol**—A language used for writing web pages that uses far less overhead, which makes it more preferable for wireless access to the Internet. WAP's corresponding OS is that created by 3Com in its Palm Pilot. Nokia has recently adopted the Palm OS for its web-capable cellular phone.